

Osvaldo Gratacós  
Vice President and CAO  
Office of the Compliance Advisor Ombudsman  
International Finance Corporation  
2121 Pennsylvania Avenue NW  
Washington, DC 20433 USA

E-mail: CAO@worldbankgroup.org

October 11, 2017

Dear Vice President Gratacós

**Re: Complaint concerning IFC investments in and financing to RCBC**

1. The Philippine Movement for Climate Justice (“**PMCJ**”) is submitting this complaint to the Office of the Compliance Advisor Ombudsman regarding IFC’s investment in Rizal Commercial Banking Corporation (“**RCBC**”).
2. RCBC was established in 1960 as a development bank and is licensed by the Bangko Sentral ng Pilipines (BSP) for commercial and investment banking. It is one of the largest universal banks in the Philippines with total consolidated resources of PhP 5.16.1billion as of end-2105. RCBC is majority-owned by the Yuchengco Group of Companies (YGC), one of the largest conglomerates in Southeast Asia. Other significant investors in RCBC, in addition to the IFC, include Cathay Life Insurance Co. Ltd, a wholly owned subsidiary of Taiwanese company Cathay Financial Holding, Ltd.<sup>1</sup>
3. Since becoming a client of IFC, RCBC has provided finance to at least 19 active and proposed coal-fired power plants across the Philippines or to companies that own or operate them. These power plants are contributing to the crisis of global climate change and causing other serious environmental and social harms, or are likely to cause harms once they commence development and operation. **Annex 1** contains the list of projects, their locations, current status and financial support received from RCBC.
4. PMCJ is an alliance of over 100 national and grassroots organizations and networks that are leading the fight against climate change in the Philippines. The 19 coal projects, individually and cumulatively, will have devastating environmental and social impacts, including through their contribution to climate change. The Philippines is one of the most vulnerable countries to climate change impacts, including extreme weather events. These impacts affect us both as Filipino citizens and residents, and as a movement fighting for climate justice.
5. PMCJ also submits this complaint on behalf of communities and families who are suffering or stand to suffer from localized social and environmental harms caused by their exposure to the development and operation of the power plants. These complainants are geographically dispersed throughout the 19 areas in the Philippines that currently host or have been identified as prospective sites of the coal plants. Complainants are farmers, fishers, indigenous peoples, rural workers, elderly, women and

---

<sup>1</sup> <https://www.rcbc.com/About/CorporateProfile>

children who reside in close proximity to the project sites. In areas where the coal plants are already operational, the complainants have suffered from physical and economic displacement and impacts to their health and environment among other harms. The same impacts are expected in the areas in which coal power plants are proposed. Authorizations of affected communities for representation by PMCJ accompany this letter of complaint, attached as **Annex 3**.

6. Due to concerns for their personal security, the community complainants request that their identities be kept confidential.

7. We prepared this complaint with the support of Inclusive Development International (“**IDI**”). Bank Information Center (“**BIC**”) has also provided support to PMCJ. We have asked IDI and BIC to advise and support us throughout this process.

8. Please direct all correspondence related to the complaint to:

- Bibiano C. Rivera Jr, PMCJ: [nationalcoordinatorpmcj@gmail.com](mailto:nationalcoordinatorpmcj@gmail.com)
- Jose Aaron Pedrosa Jr. PMCJ: [aaron\\_perosa@yahoo.com](mailto:aaron_perosa@yahoo.com)
- Natalie Bugalski: [natalie@inclusivedevelopment.net](mailto:natalie@inclusivedevelopment.net); and David Pred: [david@inclusivedevelopment.net](mailto:david@inclusivedevelopment.net) of IDI
- Nezir Sinani, BIC: [nsinani@bankinformationcenter.org](mailto:nsinani@bankinformationcenter.org)

9. This complaint is set out as follows: **Section 1** and Annex 1 explain the financial links between IFC and the 19 coal projects that we are able to ascertain from available information; **Section 2** sets out IFC’s applicable policy requirements and the information available to us that demonstrates the failure of IFC and its client to comply with these requirements; **Section 3** sets out the ways in which IFC’s sub-clients are failing to meet IFC Performance Standards with respect to greenhouse gas emissions and climate impacts as well as the World Bank Group’s criteria on coal power projects and the consequent harms to PMCJ; **Section 4** describes the immediate and proximate harms and human rights violations experienced, or likely to be experienced, by the local community complainants and the attendant failures to meet the Performance Standards; **Section 5** describes the risks to environmental activists in the Philippines, including the murder of at least one activist fighting coal projects linked to RCBC and IFC; and **Section 6** contains the outcomes sought by the complainants.

---

## PREFATORY STATEMENT

The Philippines has consistently ranked in the world’s top 10 countries most vulnerable to climate change impacts, including the exacerbation and increased frequency of extreme weather events. This vulnerability was made clear when the country was ravaged by Typhoon Haiyan in 2013, which was the strongest typhoon in recorded history to make landfall. Haiyan affected more than 14% of the country’s then population of 100 million, leaving a massive trail of death and destruction. The country’s weather bureau estimates that an average of 20 typhoons will hit the Philippines on a yearly basis with at least five developing into super typhoons akin to Haiyan. The country’s vulnerability to extreme weather was also demonstrated by the 10-month drought from 2015 to 2016 due to “strong” El Nino. While El Nino events are prompted by natural fluctuation in ocean temperatures, human-caused climate change is likely to worsen such droughts. The devastating drought of 2015-2016 resulted in highway blockades of affected farmers in

southern Philippines as they had to resort to eating field rats to survive. The government responded by firing at the helpless farmers in what is now known as the Kidapawan massacre.

Compounding these extreme weather events are slow onset-impacts wrought by climate change. Sea levels in the Philippines have been found to be rising at a rate five times the global average.<sup>2</sup>

The Philippines is among the world's mega-diversity hotspots with endemic species populating the archipelago. This is threatened by the influx of destructive projects such as large-scale mining and coal plant projects. The latter has been heavily promoted by both private sector and the government even as official estimates place renewable energy potential at more than 260,000 MW. The unabated investment in coal plant projects amplifies the vulnerability of communities to climate change impacts, undermining efforts to boost the country's adaptive capacity to a destabilizing climate. The support provided by financial institutions such as the IFC to the coal industry further pushes the country down the path to assured perdition.

---

## **SECTION 1: FINANCIAL LINKS BETWEEN IFC AND 19 COAL-FIRED POWER PLANTS**

10. There is limited transparency of IFC's financial intermediary portfolio. IFC publicly releases very little information about its financial intermediary transactions, and what it does publish on its website is not always accurate and reliable. In relation to its investments in commercial banks, IFC does not publish any information on its sub-clients. As a result, it is extremely challenging for project affected people to find out whether IFC is indirectly financing the project and whether, by consequence, they have entitlements under the Performance Standards and access to the CAO should those standards not be met. This badly inhibits accountability and access to remedies, and is contrary to the spirit and principles of IFC's Access to Information Policy (2012). In particular, we point to paragraph 8, which states:

“Taking into account its roles and responsibilities, IFC **makes available information concerning its activities that would enable** its clients, partners and stakeholders (including **Affected Communities**), and other interested members of the public, **to understand better, and to engage in informed discussion about, IFC's business activities, the development outcomes and other impacts of its activities,** and its overall contribution to development.”

This important objective and requirement of the Access to Information Policy, which reflects a human right of people directly affected by investment projects, is abrogated when it comes to those affected by IFC sub-projects through intermediaries.

11. In this case, IDI identified the financial links between the IFC and the projects causing harms and brought this information to our attention.

---

<sup>2</sup> See <https://arstechnica.com/science/2016/02/ocean-levels-in-the-philippines-rising-at-five-times-the-global-average/>

12. IFC has multiple active investment and financing relationships with RCBC:

- In 2011, IFC made a US\$48.31 million equity investment in RCBC in the form of common shares,<sup>3</sup> which, according to news reports, gave it a 7.2% stake in the bank and a seat on RCBC's Board of Directors.<sup>4</sup>
- In 2013, IFC made an additional US\$100 million equity investment, also in the form of common shares,<sup>5</sup> increasing its stake to approximately 12%.<sup>6</sup>
- In 2014, IFC provided a US\$30 million dollar loan to RCBC in order to "expand the volume and maturity of its US\$-denominated SME loan portfolio."<sup>7</sup>
- In 2015, IFC participated in a bonds issue, as an anchor investor, purchasing US\$75 million worth of bonds to, inter alia, "support RCBC's effort in expanding its lending to infrastructure projects."<sup>8</sup> IFC's additionality was to lend credibility to RCBC's efforts to raise long-term funds from the market and mobilize other investors.

13. RCBC has provided financial support to each of the 19 coal plant projects or companies. The details of each of these transactions are set out in **Annex 1**. All of these transactions occurred after IFC made its second equity investment in RCBC in early 2013.

14. Proceeds of IFC's 2011 and 2013 equity investments in RCBC could have been used for all of these transactions, establishing a clear financial link between IFC and the coal projects. Moreover, proceeds of RCBC's 2015 bonds issue, for which IFC was an anchor investor, could have been used for subsequent RCBC support to the companies or projects.

---

## **SECTION 2: FAILURES TO COMPLY WITH IFC POLICY REQUIREMENTS**

15. The 2011 equity investment is subject to IFC's 2006 Sustainability Framework, including its Policy and Performance Standards on Social and Environmental Sustainability. The 2013 investments and subsequent transactions are subject to IFC's 2012 Sustainability Framework. The transactions between RCBC and the companies and coal projects all occurred after 2012. Therefore, the 2012 policy is applicable to this complaint.<sup>9</sup>

16. IFC categorized its 2013 investment in RCBC as FI-1,<sup>10</sup> defined as having "substantial financial exposure to business activities with potential significant adverse

---

<sup>3</sup> IFC Project Information Portal, Project Number 30235.

<sup>4</sup> Business World online, "IFC acquiring stake in RCBC," (March 9, 2011). <http://www.bworldonline.com/content.php?id=27641>

<sup>5</sup> IFC Project Information Portal, Project Number 32853.

<sup>6</sup> Inquirer, "IFC hikes stake in RCBC," (September 20, 2017). <http://business.inquirer.net/110237/ifc-hikes-stake-in-rcbc>

<sup>7</sup> IFC Project Information Portal, Project Number 34115.

<sup>8</sup> IFC Project Information Portal, Project Number 37489.

<sup>9</sup> IFC Policy on Environmental and Social Sustainability (2012).

[http://www.ifc.org/wps/wcm/connect/Topics\\_Ext\\_Content/IFC\\_External\\_Corporate\\_Site/Sustainability-At-IFC/Policies-Standards/Sustainability-Policy/](http://www.ifc.org/wps/wcm/connect/Topics_Ext_Content/IFC_External_Corporate_Site/Sustainability-At-IFC/Policies-Standards/Sustainability-Policy/)

<sup>10</sup> IFC Project Information Portal, Project Number 32853.

environmental and social risks or impacts that are diverse, irreversible, or unprecedented.”<sup>11</sup> According to paragraph 35 of the policy, at the time of entering into the transaction, IFC had to place social and environmental conditions on its investments appropriate to this level of risk. One of these conditions was for RCBC to “require higher risk business activities that [it] support[s] to apply relevant requirements of the [IFC] Performance Standards.”<sup>12</sup> Another requirement, according to the policy, was for RCBC to establish and maintain an Environmental and Social Management System (“**ESMS**”) commensurate with the level of risk in its portfolio, and prospective business activities, to ensure, inter alia, that its higher risk investments meet the Performance Standards.<sup>13</sup>

17. Following the investment, IFC had to monitor and supervise RCBC’s environmental and social performance. According to paragraph 45 of the policy, IFC’s supervision should involve a periodic review of RCBC’s process and results of environmental and social due diligence. If shortcomings are identified, IFC is to help RCBC address them.<sup>14</sup> With representation on RBC’s board of directors, IFC’s supervisory role should have been easy to fulfill. Furthermore as IFC considered additional investments in RCBC in 2014 and 2015, its due diligence processes should have been amplified.

18. We do not have access to the loan agreement between IFC and RCBC, so we do not know if the terms and conditions in that agreement were consistent with IFC policy. IFC does not publicly disclose this information, inhibiting public scrutiny and accountability.

19. In its public disclosure, IFC notes that at the time of the 2013 investment, RCBC had not yet started to implement an ESMS. IFC states: “no E&S due diligence or other procedures are yet in place to address the risks and mitigations associated with the client’s portfolio.”<sup>15</sup> This is despite the earlier 2011 IFC investment in RCBC for which the development of an ESMS “prior to distribution to the satisfaction of IFC” was a condition, according to IFC’s project disclosures.<sup>16</sup> At the time of the 2015 bonds purchase, IFC stated that RCBC “will be required to strengthen its existing ESMS.”<sup>17</sup>

20. We have searched RCBC’s website and cannot find any sign that in 2017 it has an ESMS in place.<sup>18</sup> For example, we searched for, but could not find, a statement on environmental and social risk management of the bank’s lending and investment portfolio; nor could we find a grievance mechanism for people affected by projects financed by the bank. RCBC’s website does, in comparison, describe its governance of credit, liquidity, market reputational and other types of risk.<sup>19</sup>

21. As stark evidence that RCBC does not have a functioning environmental, social and governance (ESG) risk management system in place, the bank was included in business intelligence provider RepRisk’s 2016 ten most controversial companies report. RepRisk describes how RCBC was linked to a multi-million dollar international money-laundering scheme related to a February 2016 cyber theft of almost USD 1 billion from accounts

---

<sup>11</sup> IFC Policy on Environmental and Social Sustainability (2012), paragraph 40.

<sup>12</sup> IFC Policy on Environmental and Social Sustainability (2012), paragraph 35.

<sup>13</sup> Ibid.

<sup>14</sup> Ibid, paragraph 45.

<sup>15</sup> IFC Project Information Portal, Project Number 32853.

<sup>16</sup> IFC Project Information Portal, Project Number 30235.

<sup>17</sup> IFC Project Information Portal, Project Number 37489.

<sup>18</sup> RCBC. <https://www.rcbc.com/>

<sup>19</sup> RCBC, Corporate Governance. [https://www.rcbc.com/Others/corporate\\_governance\\_erm](https://www.rcbc.com/Others/corporate_governance_erm).

owned by the Central Bank of Bangladesh at the Federal Reserve Bank of New York. In August 2016, RCBC was fined USD 20 million by the Philippines authorities for negligence and failure to block withdrawals of the laundered funds. The manager of the branch concerned stated that the bank's senior officials had authorized the withdrawal despite being informed that the funds might have been stolen.<sup>20</sup>

22. Since IFC's 2013 equity investment, RCBC has provided financial support to 19 coal-fired power projects and project owners. Coal plants are known to have the highest environmental and social risks. Cumulatively, the 19 projects pose maximum risk to the environment. RCBC's financial support has come in the form of debt investments, through both syndicated loans and bonds. In many cases, RCBC was either an arranger of the syndicated loans or the joint lead manager of bond issues. (See Annex 1.) Arrangers of syndicated loans and lead managers of bond issues have considerable influence over the terms of the transactions, including in relation to ESG matters. In these cases, RCBC should have required the application of the Performance Standards as a term of the syndicated loan or bonds issue. In cases in which RCBC had limited leverage and could not influence the terms of the transaction, at the very least, it should have made a "no go" decision after screening against the objectives of Performance Standards, which were clearly unlikely to be met (see below).

23. Affected communities, and Filipino civil society, have not been consulted about any of the 19 coal plant projects. Those projects already in operation are polluting the environment, causing displacement and a raft of other negative impacts, described in detail below.

24. It is therefore apparent that IFC has not complied with its policies and procedures in relation to RCBC. IFC has, either or both, failed to require RCBC to place an obligation on its clients to apply the Performance Standards to higher risk activities, and/or failed to ensure through its own supervision that RCBC has in place an adequate ESMS that ensures the standards are met.

---

### **SECTION 3: CONTRAVENTIONS OF IFC STANDARDS ON COAL-FIRED POWER GENERATION AND CLIMATE CHANGE**

25. Under Performance Standard (PS) 1, an environmental and social impact assessment is required for IFC-supported projects that are likely to generate negative impacts. PS1 specifically requires the identification of project risks and impacts with respect to greenhouse gas (GHG) emissions and "the relevant risks associated with a changing climate."<sup>21</sup> PS3 requires IFC clients and sub-clients to consider alternatives and implement technically and financially feasible and cost-effective options to reduce project-related GHG emissions during the design and operation of the project. The adoption of renewable or low carbon energy sources should be considered.<sup>22</sup>

---

<sup>20</sup> RepRisk, "Most Controversial Companies (MCC) 2016," at: <https://www.reprisk.com/content/5-publications/1-special-reports/46-most-controversial-companies-of-2016/mcc-2016.pdf>

<sup>21</sup> PS1, paragraph 7.

<sup>22</sup> PS3, paragraph 7.

26. This requirement should have been included in each transaction between RCBC and its clients involved in operating, developing and expanding the coal-fired power plants. These impact assessments should have included consultations with affected communities, and the Filipino public more broadly. We are not aware of any such impact assessments for the 19 coal projects and none of the complainants have been shown any such assessments or been consulted on the projects, their impacts, mitigation measures or alternatives.

27. In addition to individual project GHG emission and climate change impact assessments, RCBC's extensive financing of the coal sector, should have warranted a cumulative impact assessment of its contribution to climate change. With its large stake in RCBC and a seat on its board of directors, IFC should have been cognizant of the bank's deep exposure to the coal sector, and insisted on a cumulative impact assessment, including identification and assessment of alternatives. As an IFC intermediary client, RCBC should have assessed its exposure to the coal sector, the impact of this exposure on climate change and actively sought out ways to reduce this exposure and increase its support to renewable and low carbon energy generation projects.

28. The requirements of the Performance Standards (and accompanying Guidance Notes) with respect to GHG emissions and their implications for support to coal-fired power generation lack detail. These requirements need urgent modernization to reflect the Paris Climate Agreement of 2015. Given their brevity and insufficiency, the requirements should be read in the context of two other pertinent institutional documents:

- "Towards a Sustainable Energy Future for All: Directions for the World Bank Group's Energy Sector," issued in 2013 (known as the World Bank Group's Energy Sector Strategy Paper); and
- "Criteria for Screening Coal Projects under the Strategic Framework for Development and Climate Change: Operational Guidance for World Bank Group Staff", issued in 2010.

29. The Energy Sector Strategy Paper committed the World Bank Group to limiting its exposure to coal projects. In relation to support to new coal projects, the strategy paper states:

**The WBG will provide financial support for greenfield coal power generation projects only in rare circumstances.** Considerations such as meeting basic energy needs in countries with no feasible alternatives to coal and a lack of financing for coal power would define such rare cases. The "Criteria for Screening Coal Projects under the Strategic Framework for Development and Climate Change" will apply to all greenfield coal power projects undertaken in such exceptional circumstances.<sup>23</sup>

In relation to support to existing coal plants, the strategy paper states:

**The WBG will support interventions that reduce the GHG emissions associated with coal-combustion plants.** Efficiency improvements at existing plants are among the most cost-effective means of reducing local and global

---

<sup>23</sup> World Bank Group (2013), *Toward a Sustainable Energy for All: Directions for the World Bank Groups' Energy Sector*, at paragraph 58.

environmental impacts of coal, and for this reason, the WBG will consider providing support aimed at increasing the efficiency of [...] coal-fired power generation (subject to the applicable coal screening criteria). The WBG would also consider support for greenfield as well as existing coal-fired plants with operating carbon capture, which offers the possibility of substantially reducing GHG emissions from coal-fired plants.<sup>24</sup>

30. The Criteria for Screening Coal Projects are:<sup>25</sup>

1. There is a demonstrated developmental impact of the project, including improving overall energy security, reducing power shortage or increasing access for the poor;
2. Assistance is being provided to identify and prepare low carbon projects;
3. Energy sources are optimized, looking at the possibility of meeting the country's needs through energy efficiency (both supply and demand) and conservation;
4. After full consideration of viable alternatives to the least cost (including environmental externalities) options, and when the additional financing from donors for their incremental cost is not available;
5. Coal projects will be designed to use the best appropriate available technology to allow for high efficiency and, therefore, lower GHG emissions intensity; and
6. An approach to incorporate environmental externalities in project analysis will be developed.

31. We do not believe these criteria have been met in the case of the 19 coal plants. There does not appear to have been any consideration of alternatives, and in particular, renewable energy generation, which should have been a condition of RCBC financing. We have not seen any evidence that environmental externalities were incorporated into project analysis and costs, and then compared with the costs of alternatives. We are skeptical that such analysis was carried out. If it were, a comprehensive analysis would have captured the enormous costs of environmental externalities, including GHG emissions and contribution to climate change. With the costs of renewable energy generation and storage declining sharply in recent years,<sup>26</sup> we are confident that a cost comparison would support an investment in renewables, especially for greenfield projects.

32. With the Philippines' huge potential for renewable energy development, all Filipinos, especially the poor, marginalized, and vulnerable, should have access to clean, safe, and affordable energy. PMCJ assesses that by 2030, the potential exists for 100% of the country's energy to come from renewables.

33. Based on the evidence, PMCJ does not believe that there is such a thing as "clean coal." Clean coal technology, or the use of circulating fluidized bed (CFB) combustion systems, emits four times more coal ash compared to ordinary coal plants. CFB technology does not arrest carbon dioxide emissions; does not absolutely prevent toxic metal compound pollution; and does not address risk and hazards arising from coal ash

---

<sup>24</sup> Ibid, at paragraph 59.

<sup>25</sup> World Bank, IDA, IFC and MIGA, Operational Guidance for World Bank Staff: Criteria for Screening Coal Projects under the Strategic Framework for Development and Climate Change (March 2010).

<sup>26</sup> See: <https://www.theguardian.com/environment/2017/jun/06/spectacular-drop-in-renewable-energy-costs-leads-to-record-global-boost>



exposure.<sup>27</sup> We therefore reject the notion suggested by criterion 5 that new coal projects may be acceptable so long as they are designed to use certain technologies. Even coal plants that use so-called ultra supercritical technologies cause destructive amounts of GHG emissions that our planet cannot sustain. In any case, none of the coal projects across the Philippines supported by IFC and RCBC use ultra supercritical pulverized coal. In cases in which coal plants are being expanded, there is no indication that efficiency improvements will be made to reduce GHG emission intensity.

34. Therefore neither the Performance Standards (1 and 3), nor the criteria for screening coal projects have been met. The rare circumstances necessary to justify World Bank Group support to coal projects, and indeed the expansion of the coal sector in the Philippines, simply do not exist. We submit that the same standards and criteria should apply to IFC financial intermediaries, particularly those in which IFC holds such huge leverage: in this case, through its large equity stake, a seat on the board and role as an anchor investor to attract finance.

35. The need for increased energy security and greater access for the poor in the Philippines is undeniable. According to the World Bank, 10% of Filipino households do not have access to electricity at all.<sup>28</sup> According to the Philippines' Energy Department, 22 million Filipinos suffer from energy poverty. But pursuing a massive expansion of coal-fired power plants is not the answer.

36. In 2013, right around the time IFC made its second major equity investment in RCBC, the World Bank published a report called, "Getting a grip on climate change in the Philippines."<sup>29</sup> The report emphasizes that the Philippines is the third most vulnerable country to weather-related extreme events and sea level rise, and that the Filipino people are already feeling the impacts of climate change. The biggest impacts are expected to be felt by coastal populations, because of increases in storm surges, affecting some 14% of the total population, and urban informal settlements, because of the poor condition of their infrastructure, affecting some 45% of the total urban population. The report draws the connection between poverty and the impacts of climate change, emphasizing that the Filipino people, and especially the poor, face severe risks of food insecurity and deteriorations of their livelihoods, unless there is dramatic intervention.

37. In the wake of the global agreement at COP21 in Paris in 2015, the World Bank Group committed to supporting the international community to limit the increase in global average temperature to 1.5 degrees Celsius above pre-industrial levels in order to avoid the worst impacts of climate change.<sup>30</sup> The latest scientific research suggests that it is still possible to achieve this target, but the window is closing rapidly. Carbon emissions must decline sooner than what was proposed by the more than 180 countries that submitted national pledges for climate action in Paris.<sup>31</sup> In a few years, unless drastic

---

<sup>27</sup> Aaron Pedrosa and Romil Hernandez, "Visayas Base Load Power Development Project: A Model for Greenfield Power Plants (Particularly Coal-Fired) in the Philippines," Mainstreaming Climate Change into the Environmental Impact Process, 2011; available at:

<https://www.scribd.com/document/56865519/Visayas-Base-Load-Power-Development-Project>

<sup>28</sup> See: <http://documents.worldbank.org/curated/en/845411468196760448/pdf/72689-PAD-P147646-OUO-9-Box394874B-R2016-0075-1.pdf>

<sup>29</sup> <http://documents.worldbank.org/curated/en/473371468332663224/pdf/788090WP0P13010nge0Executive0Report.pdf>

<sup>30</sup> <http://www.worldbank.org/en/news/feature/2015/12/12/paris-agreement-paves-way-for-world-bank-group-helping-countries-deliver-on-climate-commitments>

<sup>31</sup> Richard Millar, et al, "Emission budgets and pathways consistent with limiting warming to 1.5 degrees

changes in energy consumption and development are undertaken, 1.5 degrees will no longer be possible and the world will face the “severe, widespread and irreversible impacts” of climate change predicted by the UN’s Intergovernmental Panel on Climate Change (IPCC).<sup>32</sup>

38. It is well understood that this requires a rapid transformation of the energy system, in which reliance on fossil fuels, and particularly coal, is phased out and replaced with clean and safe renewable energy. The World Bank Group set a goal of devoting 28 percent of its portfolio to climate finance by 2020.<sup>33</sup>

39. And yet, while the World Bank has recently publicized a loan to the Philippines worth USD 44 million to catalyze private investment in renewable energy,<sup>34</sup> the IFC has quietly funneled hundreds of millions into RCBC, which is bankrolling the expansion of the country’s coal sector on its watch. In its project documentation, the World Bank observed of the Philippines energy sector that the “generation mix has [previously] been balanced among renewables, coal and natural gas, but it is changing as more coal-fired power plants come on-line.”<sup>35</sup> What the World Bank does not say is that financing for those plants is coming, albeit indirectly, from the World Bank Group.

---

#### **SECTION 4: ADDITIONAL LOCALIZED HARMS AND CONTRAVENTIONS OF IFC PERFORMANCE STANDARDS**

40. Local communities impacted by those coal projects already in operation, development or undergoing expansion have faced a panoply of environmental and social harms. While we were unable to undertake a comprehensive risk and impact assessment due to the sheer number of people affected by the 19 plants across the country, complainants have reported serious disruption to their lives. Almost the full suite of IFC Social and Environmental Performance Standards are relevant and have not been met by RCBC’s clients who own and operate the coal plants.

41. None of the complainants felt that they were properly informed or effectively consulted about the coal plants being developed in their neighborhoods and their impacts. None of the complainants are aware of a grievance mechanism they can access to register their concerns and have them resolved. None of the projects are in compliance with Performance Standard 1.

42. Complainants in Mariveles, Bataan (project 4 as listed in Annex 2), Limay, Bataan (project 5), Batangas City, Batangas (project 8), Pagbilao, Quezon (project 11), Kauswagan, Lanao del Norte (project 17), and Davao City, Davao del Sur (project 18)

---

C,” *Nature Geoscience*, September 18, 2017, at:

<http://www.nature.com/ngeo/journal/vaop/ncurrent/full/ngeo3031.html?foxtrotcallback=true>

<sup>32</sup> UNIPCC, *Climate Change 2014 Synthesis Report, Fifth Assessment Report, SPM 3.2, 3.4*, at:

[http://ar5-syr.ipcc.ch/ipcc/resources/pdf/IPCC\\_SynthesisReport.pdf](http://ar5-syr.ipcc.ch/ipcc/resources/pdf/IPCC_SynthesisReport.pdf)

<sup>33</sup> <http://www.worldbank.org/en/news/feature/2015/12/12/paris-agreement-paves-way-for-world-bank-group-helping-countries-deliver-on-climate-commitments>

<sup>34</sup> World Bank Press Release May 12, 2016. <http://www.worldbank.org/en/news/press-release/2016/05/12/philippines-world-bank-approves-two-projects-to-expand-electricity-access-for-poor-remote-households>

<sup>35</sup> *Ibid.*

were displaced to make way for the plants, with compensation and resettlement either insufficient or not provided at all. Performance Standard 5 has not been met with respect to these projects.

43. Indigenous Peoples have been displaced from their ancestral lands without their free, prior and informed consent in Maasim, Sarangani (project 16). Performance Standard 7 has not been met with respect to this project.

44. There has been extensive economic displacement, mainly due to physical displacement of households as well as impacts on fisheries due to contamination of or blocked access to the sea, and pollution of fruit trees and crops by fly ash from the coal plants. Almost all local communities have suffered impacts to their livelihoods and have not been provided compensation or livelihood support. Performance Standard 5 has not been met.

45. Complainants affected by all projects report some form of adverse local environmental impacts, including pollution of sea, fisheries and coral reef and of land, crops and trees. In some cases, protected areas have been affected. Fly ash from several plants has caused air pollution and other adverse impacts, including to human health described below. Performance Standard 3 and 6 have not been met.

46. There have been negative impacts on human health, including respiratory diseases and skin irritations, with children especially affected in some communities. Complainants in Mariveles, Bataan (project 4), Limay, Bataan (project 5), and La Paz, Iloilo City, Iloilo (project 14) report serious health impacts from the coal plants. Performance Standard 4 has not been met with respect to these projects.

47. Communities living near sites of proposed coal plants have seen or heard from those affected by existing plants about the harms they have suffered and fear that they will soon face similar negative impacts.

48. The Table of Harms in **Annex 2** contains a non-exhaustive description of localized harms experienced and feared by complainants affected by each of the 19 coal plant projects.

## **SECTION 5: THREATS AND MURDERS OF ENVIRONMENTAL ACTIVISTS FIGHTING COAL IN THE PHILIPPINES**

49. PMCJ members and other environmental activists in the Philippines who oppose the development of these coal projects are operating in an increasingly risky political environment. We face threats from coal companies, local police, officials and criminal networks who collude with them.

50. In 2014, Global Witness published, “*Deadly Environment?*”, which reported verifiable murders of environmental and land activists between 2002-2013 in 74 countries. Global Witness found that the Philippines had the highest number of murders of activists in Asia.<sup>36</sup> This dangerous political environment should have been taken into account by IFC during its due diligence of its investments in RCBC, which occurred during this period, especially in light of the bank’s high exposure to coal projects.

---

<sup>36</sup> <https://www.globalwitness.org/en/campaigns/environmental-activists/deadly-environment/>

51. Global Witness continues to name the Philippines as one of the most dangerous places in the world to be an environmental or land defender.<sup>37</sup> An estimated 28 environmental and land activists were killed in the Philippines in 2016.<sup>38</sup> In August 2017, President Rodrigo Duterte openly called on the police to shoot human rights defenders “for obstructing justice”, loosely referring to his bloody war on drugs.<sup>39</sup> At least ten environmental activists have been killed since Duterte’s inauguration on June 30, 2016.<sup>40</sup>

52. One of these brave activists was Gloria Capitan, an active member of the Coal-Free Bataan Movement fighting the three coal projects in Bataan province supported by RCBC and IFC. Capitan’s family experienced the impacts of coal projects firsthand. Her granddaughter suffered health problems associated with exposure to coal dust. On July 1, 2016, Capitan, grandmother of 18, was murdered by two assassins on motorbikes. She had faced threats and intimidation before, and there is little doubt she was killed because of her activism.<sup>41</sup>

53. Since Capitan’s death, in Limay and Mariveles, Bataan, community leaders have faced harassment and intimidation from unidentified persons inquiring about their whereabouts. At Capitan’s wake, the PMCJ delegation headed by Jose Aaron Pedrosa, Jr., noticed their vehicle marked with the same insignia which witnesses identified on the face mask worn by the assailant who killed Capitan. This forced the group to spend the night away from the community. On a separate occasion, Pedrosa himself received a death threat through an anonymous phone call. PMCJ’s Luzon Area Coordinator, Valentin de Guzman, was a victim of email hacking at the height of the Bataan anti-coal campaign. PMCJ would learn from verified sources that individuals linked to the Limay coal project were asking about de Guzman. In another coal site, Sual Pangasinan, de Guzman and Pedrosa’s faces, together with participants of a paralegal training conducted by PMCJ in the locality, have been mounted at the town square in an effort to publicly shame the community and support group leaders opposed to the proposed 900MW coal plant in the locality.

54. In Ozamis City, the groups and leaders who mobilized against the proposed 300 MW coal plant, likewise experienced harassment and intimidation when military personnel were deployed to their communities following their action. Leaders and staff members belonging to PMCJ’s member organization in the area noticed that they were being tailed by unidentified men when they drove from their homes to the field. On three occasions, the local PMCJ leader’s home was visited by the company commander of the Philippine Army doing background checks on the local staff of the member-organization.

---

<sup>37</sup> <https://www.globalwitness.org/en/campaigns/environmental-activists/filipinos-front-line/>

<sup>38</sup> The Guardian, Environmental and land defenders killed in 2016: the full list. <https://www.theguardian.com/environment/2017/jul/13/environmental-and-land-defenders-killed-in-2016-the-full-list>

<sup>39</sup> Human Rights Watch, Philippine: Duterte Threatens Human Rights Community. <https://www.hrw.org/news/2017/08/17/philippines-duterte-threatens-human-rights-community>

<sup>40</sup> Mongabay, Environmental lawyer killed in the Philippines (21 February 2017). <https://news.mongabay.com/2017/02/environmental-lawyer-killed-in-the-philippines/>

<sup>41</sup> Inclusive Development International, “Disaster for us and the planet”: How IFC is quietly funding a coal boom. (October 2016). <http://www.inclusivedevelopment.net/wp-content/uploads/2016/09/Outsourcing-Development-Climate.pdf>

55. Despite the risks that we face, we continue to fight the expansion of coal in our country. With this complaint we extend our fight to the development finance institutions bankrolling this expansion, and the exacerbation of the climate change disaster that we and the generations that will follow us face.

---

## **SECTION 5: OUTCOMES SOUGHT**

56. The community complainants already affected by the projects, are seeking full and fair redress for all the harms and losses they have suffered in line with the protections and entitlements of the IFC Performance Standards.

57. We, PMCJ and community complainants, seek to stop the projects that have not yet commenced operation and which are not consistent with the Performance Standards.

58. We urge the CAO to:

- (a) conduct an investigation of the IFC's complicity and violations of its own standards and due diligence policies in dealing with RCBC. It is prayed that the investigation include site visits and interviews with affected communities across the 19 areas in the Philippines;
- (b) compel IFC to conduct an audit into the environmental and social impacts of the 19 projects funded by RCBC, its financial intermediary, for failure to implement its own ESMS;
- (c) draft, in consultation and with active participation of herein complainants, an action plan to address the impacts being experienced by affected communities; and
- (d) recommend the provision of immediate assistance to affected communities.

59. We urge the IFC to use its considerable leverage with RCBC to ensure that it does not finance another dirty coal plant and instead directs its financing to renewable energy projects that ensure energy access for poor Filipinos without accelerating the pace of climate change.

60. If RCBC does not bring its investments into compliance with the IFC Performance Standards and commit to no more coal investments, we urge IFC to divest and exclude RCBC from future IFC investments.

61. Finally, we wish to see the IFC conduct a comprehensive, independent review of its carbon footprint, including through its financial intermediary portfolio; publicly report its findings; and terminate its relationships with financial institutions that do not, at minimum, adopt and adhere to the World Bank Group's climate and energy sector commitments.

Signed:

The Philippines Movement for Climate Justice

---

**Annex 1:  
Description of 19 coal plant projects and companies across the Philippines with financial links to RCBC<sup>42</sup>**

**1. Global Luzon Power Plant (670MW)**

**Location:** La Union, Luzon

**Status:** Proposed

**Owner:** Global Luzon Energy Development Corp., a subsidiary of Global Business Power Corp.

**Financial links to RCBC:**

- Financial links to RCBC are through Manila Electric and JG Summit Holdings, which hold large stakes in Global Business Power Corp, at 14% and 30%, respectively.
  - In December 2013, RCBC was a participating underwriter of two issues of Manila Electric Company bonds worth a total of \$419 million.<sup>43</sup>
  - In February 2014, RCBC was co-lead underwriter for three issues of JG Summit Holdings bonds worth \$672 million.<sup>44</sup> Net proceeds from the bonds were intended to partially finance JG Summit’s acquisition of Manila Electric Company and were partially for general corporate purposes.<sup>45</sup> JG Summit Holdings acquired a 29% stake in Manila Electric Company in December 2013.<sup>46</sup>

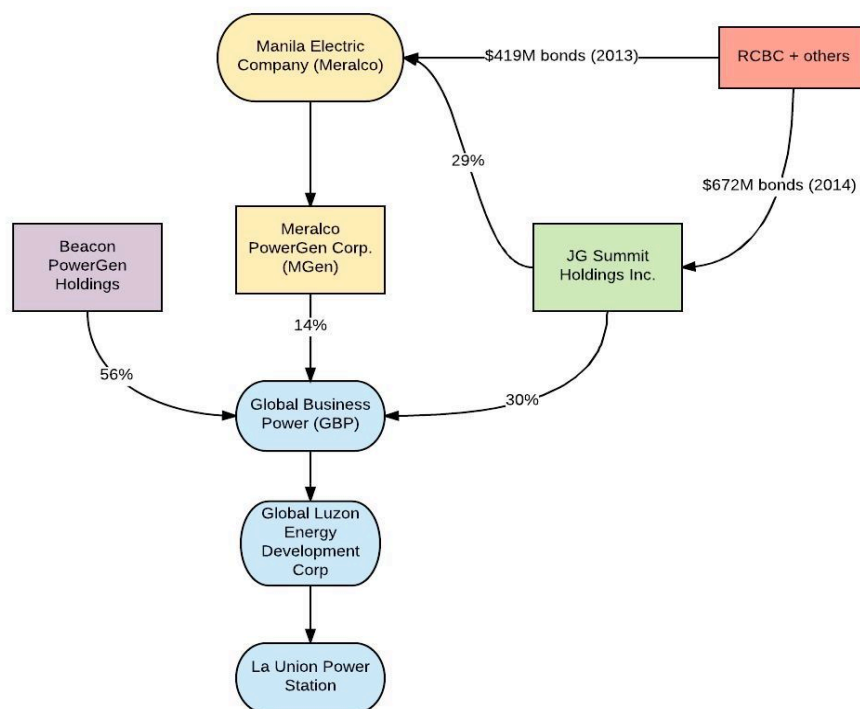

**2. Masinloc Power Plant Expansion Project (630 MW)**

<sup>42</sup> The research for this annex was provided by Inclusive Development International.

<sup>43</sup> [Prospectus](#)

<sup>44</sup> [Prospectus](#)

<sup>45</sup> <http://business.inquirer.net/165085/jg-summit-raises-p30b-from-retail-bond-offer>

<sup>46</sup> <http://www.jgsummit.com.ph/meralco>

**Location:** Masinloc, Zambales, Luzon

**Status:** Expansion of existing 295 MW coal plant to 630 MW.

**Owner:** Masinloc Power Partners

**Financial links to RCBC:**

- In 2008 (pre-dating IFC's exposure to RCBC), RCBC contributed \$50 million to a \$195 million loan tranche to finance the privatization of the power plant.<sup>47</sup>
- In December 2015, RCBC was co-arranger of a \$525 million loan to Masinloc Power Partners to expand the plant in Zambales.<sup>48</sup>

(In addition, in 2008 IFC invested directly in Masinloc Power Partners in 2008 to support privatization of the power plant, but according to IFC's project database this investment is now completed.<sup>49</sup>)

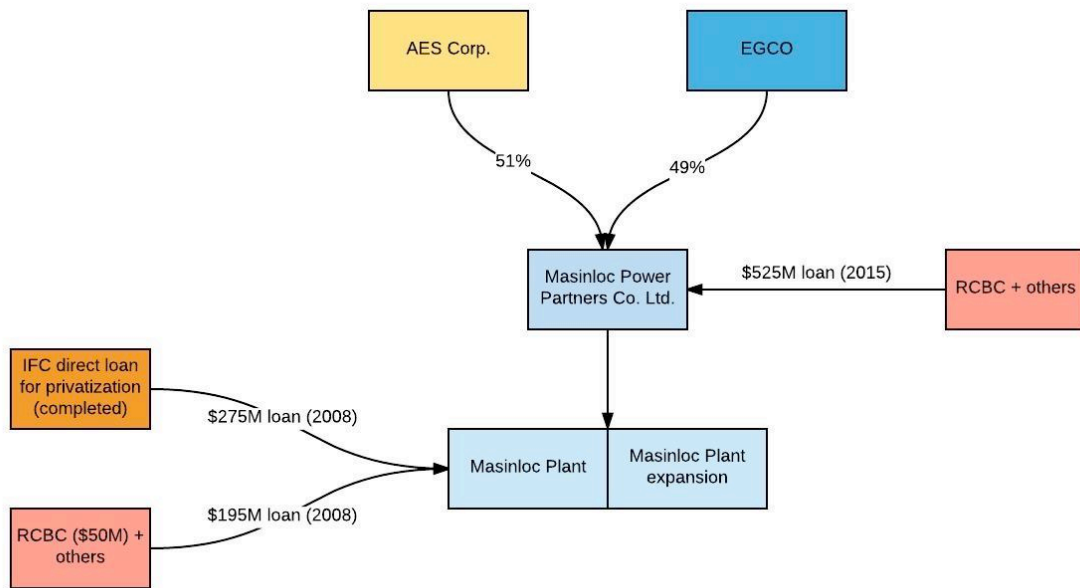

### 3. Redondo Peninsula Energy Subic Power Plant (600MW)

**Location:** Subic, Zambales, Luzon

**Status:** Construction Underway

**Owner:** Redondo Peninsula Energy, Inc.

**Financial links to RCBC:**

- In December 2013, RCBC was a participating underwriter of two issues of Manila Electric Company bonds worth a total of \$419 million.<sup>50</sup> Manila Electric holds a 47% stake in Redondo Peninsula Energy, Inc.<sup>51</sup>
- In July 2015, RCBC was a participating underwriter for \$525 million in bond issues for Aboitiz Equity Ventures Inc.<sup>52</sup> Aboitiz has a 25% equity stake in Redondo Peninsula Energy through its subsidiary Therma Power, Inc.<sup>53</sup>

<sup>47</sup> Thomson One Database

<sup>48</sup> Thomson One Database

<sup>49</sup> IFC Project Information Portal, Project Number 26405.

<sup>50</sup> [Prospectus](#)

<sup>51</sup> <http://www.rpenergy.ph/who-we-are/shareholders/>

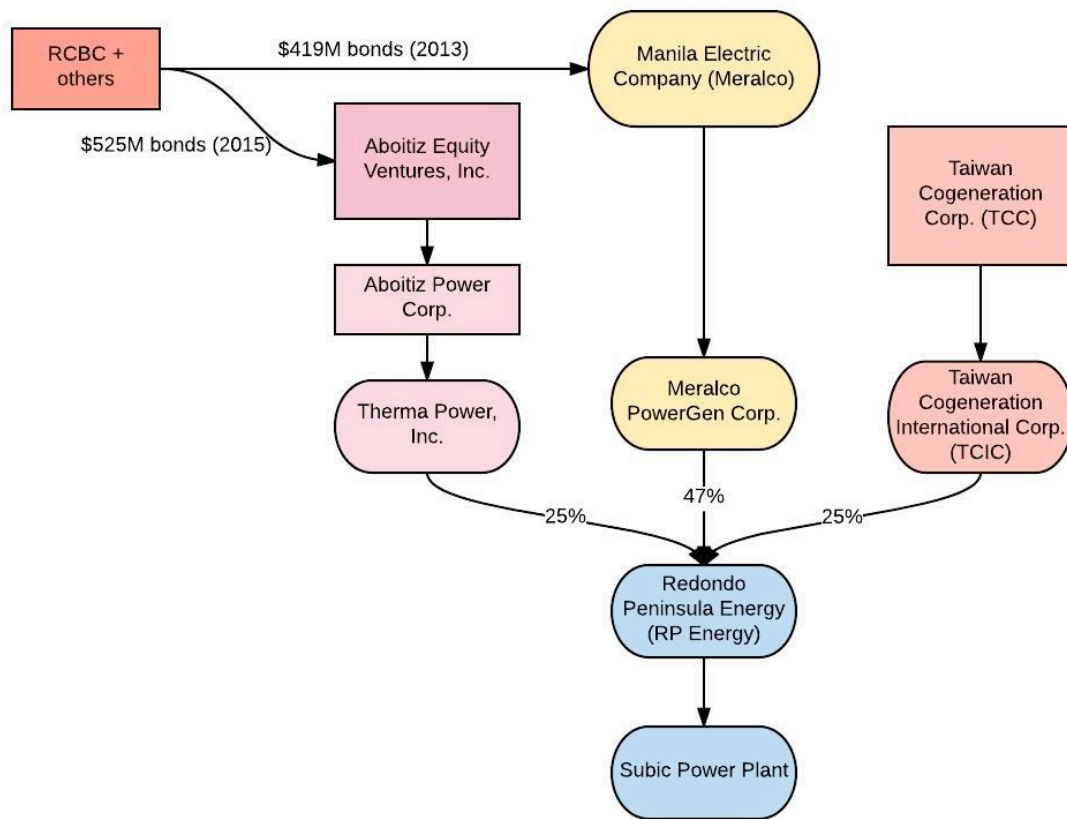

#### 4. GNPowder Mariveles Power Plant and Dinginin Power Station Expansion (1800MW)

**Location:** Mariveles, Bataan.

**Status:** Expansion. The existing 600MW GN Power Mariveles Power Project is currently undergoing expansion to include a second 1200MW plant, referred to as the Dinginin Power Station Expansion.

**Owner:** GNPowder Dinginin Ltd. Co.

##### **Financial links to RCBC:**

- In September 2016, RCBC was co-arranger of a syndicated loan of \$831 million loan to GNPowder Dinginin Ltd. Co. for the expansion of the Mariveles Power Plant.<sup>54</sup>
- RCBC has provided financial support to Ayala Corp., which through subsidiary AC Energy Holdings, holds a 50% stake in GNPowder Dinginin Ltd. Co.<sup>55</sup>
  - In May 2011, RCBC was joint bookrunner for \$232 million in Ayala Corp. bonds for working capital.
  - In May and November 2012, RCBC was joint bookrunner for an Ayala Corp bonds issue worth \$235 million and \$244 million, respectively.<sup>56</sup>

<sup>52</sup> [Prospectus](#)

<sup>53</sup> <http://www.rpenergy.ph/who-we-are/shareholders/>

<sup>54</sup> Thomson One Database

<sup>55</sup> <http://www.ayala-energyinfra.com/ac-energy/conventional-energy/gnpowder-dinginin/>



- In July 2015, RCBC was a participating underwriter for \$525 million in bond issues for Aboitiz Equity Ventures Inc.<sup>57</sup> Therma Power Inc., a wholly-owned subsidiary of Aboitiz, owns 40% of GNPower Dinginin Ltd. Co.

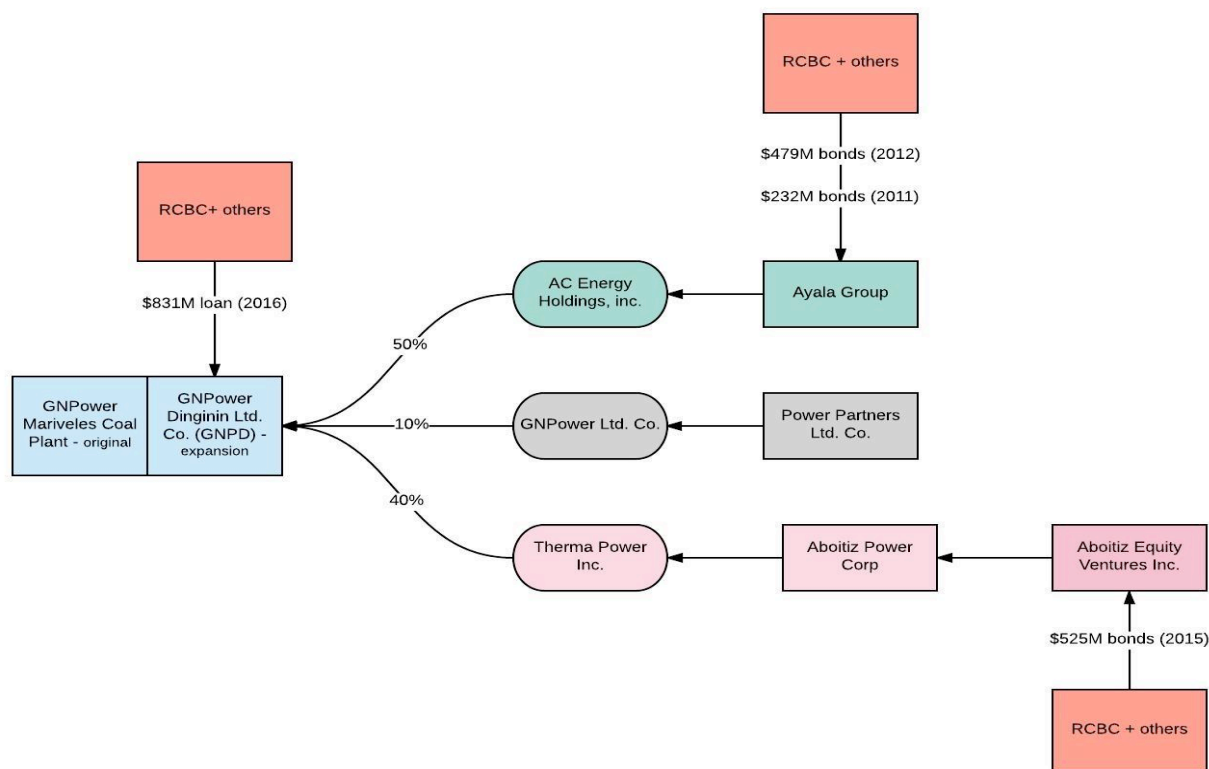

## 5. Limay Power Plant (900 MW)

**Location:** Limay, Bataan.

**Status:** Construction Underway

**Owner:** SMC Global Power Holdings Corp., a wholly-owned subsidiary of San Miguel Corporation (SMC). SMC Consolidated Power Corp. (SCPC), a subsidiary of SMC Global Power Holdings Corp., is the project operator.<sup>58</sup>

### Financial links to RCBC:

- In March and April 2017, RCBC was joint bookrunner for San Miguel Corp. bonds issues at \$397 million and \$200 million, respectively.
- In July 2016, RCBC was joint bookrunner for three San Miguel Corp Global Power Holdings bond issues worth \$316 million.<sup>59</sup>

<sup>56</sup> Thomson One Database

<sup>57</sup> [Prospectus](#)

<sup>58</sup> [http://www.smcglobalpower.com.ph/File\\_list/PDF/Other/Amended\\_SMC\\_Global\\_Annual\\_Report\\_2016\\_\(17-A\).pdf](http://www.smcglobalpower.com.ph/File_list/PDF/Other/Amended_SMC_Global_Annual_Report_2016_(17-A).pdf)

<sup>59</sup> Thomson One Database

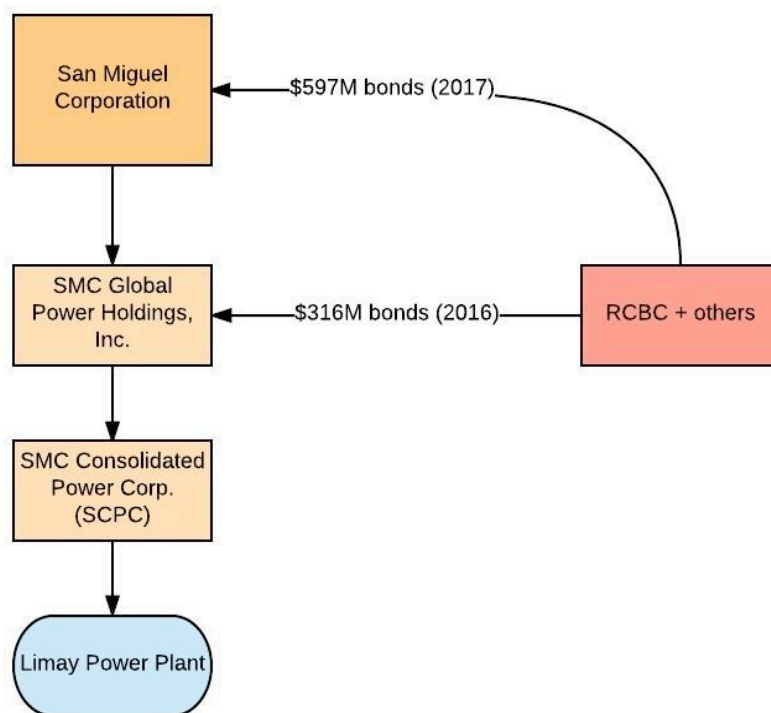

## 6. Mariveles Power Generation Corp. Power Plant (600 MW)

**Location:** Mariveles, Bataan

**Status:** Construction Underway

**Owner:** Mariveles Power Generation Corp.

### Financial links to RCBC:

- San Miguel Corp. Global Power Holdings Corp. and Manila Electric each hold 49% equity interest in Mariveles Power Generation Corp.
- In December 2013, RCBC was a participating underwriter of two issues of Manila Electric Company bonds worth a total of \$419 million.<sup>60</sup>
- In March and April 2017, RCBC was joint bookrunner for San Miguel Corp. bonds issues at \$397 million and \$200 million, respectively. In July 2016, RCBC was joint bookrunner for three San Miguel Corp Global Power Holdings bond issues worth \$316 million.<sup>61</sup>

<sup>60</sup> [Prospectus](#)

<sup>61</sup> Thomson One Database

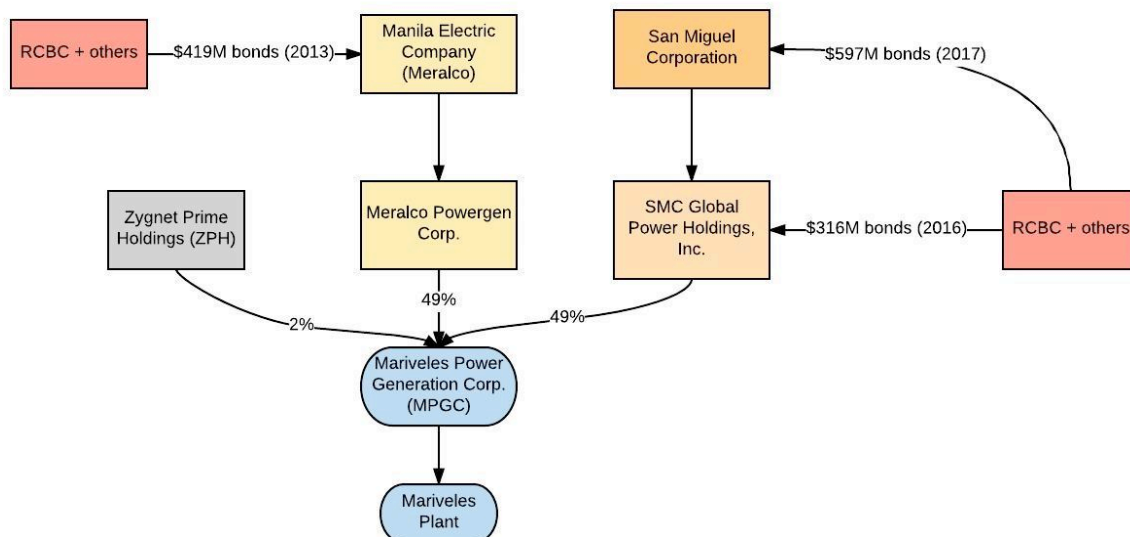

## 7. South Luzon Thermal Energy Corp. Puting Bato Power Plant (270 MW)

**Location:** Puting Bato, Calaca, Batangas

**Status:** Operational

**Owner:** South Luzon Thermal Energy Corp

### Financial links to RCBC:

- In July 2013, RCBC was part of a consortium that provided direct project finance to South Luzon Thermal Energy Corp., in the form of a \$161 million loan.<sup>62</sup>
- In May 2011, RCBC was joint bookrunner for \$232 million in Ayala Corp. bonds for working capital. In May and November 2012, RCBC was joint bookrunner for an Ayala Corp bonds issue worth \$235 million and \$244 million, respectively.<sup>63</sup> Ayala Corp, through its the wholly-owned energy subsidiary, AC Energy, holds a 35% interest in the power plant.<sup>64</sup>

<sup>62</sup> [Prospectus, page 191](#)

<sup>63</sup> Thomson One Database

<sup>64</sup> <http://www.ayala-energyinfra.com/ac-energy/conventional-energy/sltec/>

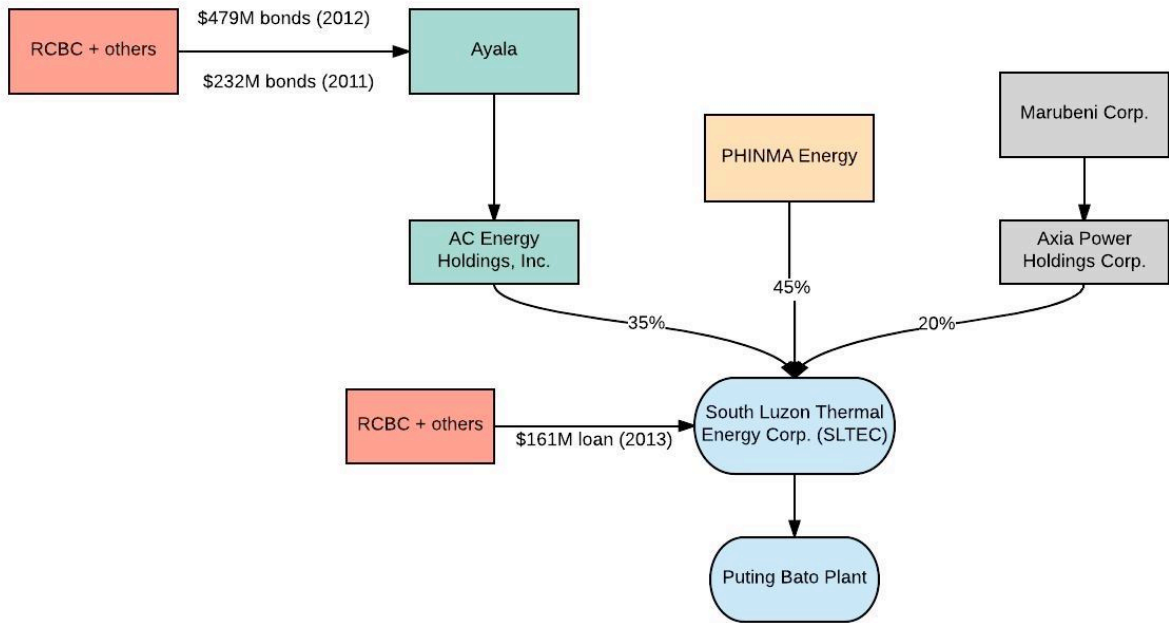

### 8. Merbau Coal-fired Thermal Plant (300 MW)

**Location:** Batangas City, Batangas

**Status:** Proposed

**Owner:** Merbau Corp., a wholly-owned subsidiary of JG Summit Holdings<sup>65</sup>

**Financial links to RCBC:**

- In February 2014, RCBC was co-lead underwriter for the three issues of JG Summit Holdings bonds worth \$672 million.<sup>66</sup>

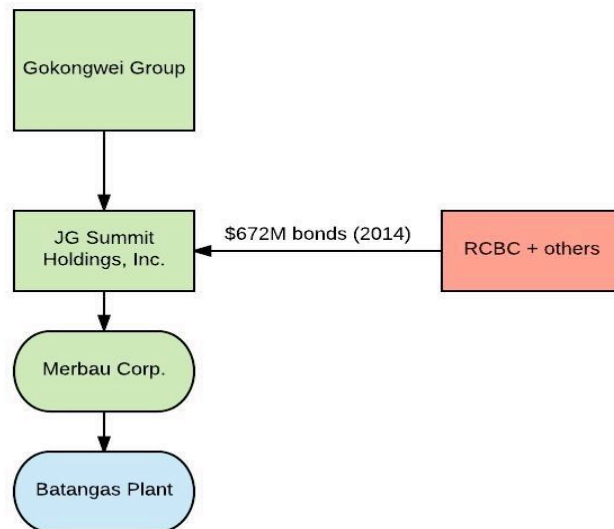

<sup>65</sup> [https://www.doe.gov.ph/sites/default/files/pdf/electric\\_power/private\\_sector\\_initiated\\_power\\_projects/luzon\\_indicative\\_2017\\_feb.pdf](https://www.doe.gov.ph/sites/default/files/pdf/electric_power/private_sector_initiated_power_projects/luzon_indicative_2017_feb.pdf)

<sup>66</sup> [Prospectus](#)

## 9. San Buenaventura Power Ltd. Co. Project (455 MW expansion)

**Location:** Mauban, Quezon

**Status:** Expansion. The existing 440MW Quezon Power Ltd. Co. project is currently undergoing expansion to include a second 455MW plant, referred to as the San Buenaventura Expansion.

**Owner:** Quezon Power Ltd. Co. (original); San Buenaventura Power Ltd. Co. (expansion)<sup>67</sup>

### Financial links to RCBC:

- In October 2015, RCBC contributed to a loan tranche worth \$915 million to San Buenaventura Power Ltd. Co to partly fund the 455 MW expansion of the Quezon Coal Power Plant.<sup>68 69</sup>
- In December 2013, RCBC was a participating underwriter of two issues of Manila Electric Company bonds worth a total of \$419 million.<sup>70</sup> Manila Electric owns 51% of San Buenaventura Power Ltd. Co.<sup>71</sup>

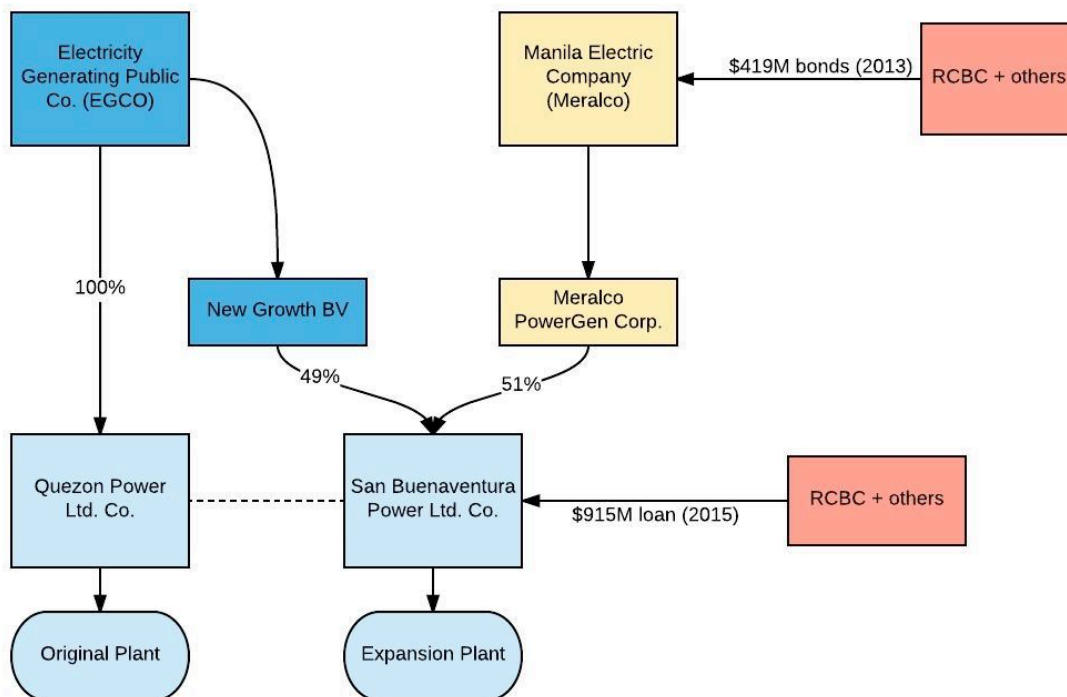

<sup>67</sup> <http://www.egco.com/en/business-group/all-countries/under-construction>

<sup>68</sup> Thomson One Database

<sup>69</sup> [https://www.doe.gov.ph/sites/default/files/pdf/e\\_ipo/2016\\_leif\\_02\\_metrobank\\_project\\_financing\\_facility.pdf](https://www.doe.gov.ph/sites/default/files/pdf/e_ipo/2016_leif_02_metrobank_project_financing_facility.pdf)

<sup>70</sup> Prospectus

<sup>71</sup> <http://www.egco.com/en/business-group/all-countries/under-construction>

## 10. Central Luzon Premiere Power Corporation Plant Project (150 MW)

**Location:** Pagbilao, Quezon

**Status:** Proposed

**Owner:** Central Luzon Premiere Power Corp., subsidiary of San Miguel Corp (SMC) Global Power Holdings.<sup>72</sup>

### Financial links to RCBC:

- In March and April 2017, RCBC was joint bookrunner for San Miguel Corp. bonds issues at \$397 million and \$200 million, respectively.
- In July 2016, RCBC was joint bookrunner for three San Miguel Corp Global Power Holdings bond issues worth \$316 million.<sup>73</sup>

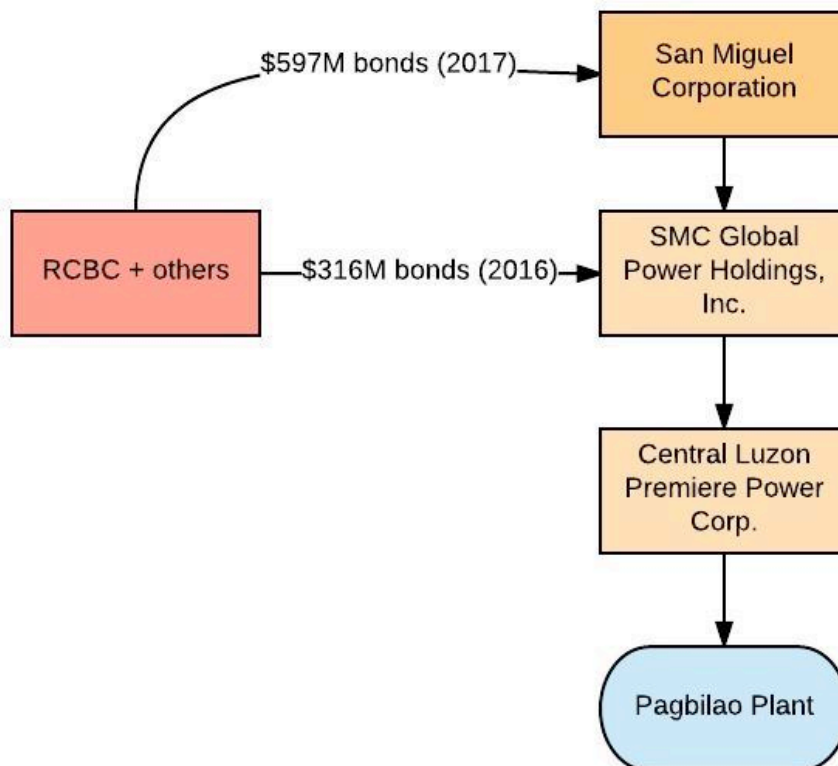

## 11. Pagbilao Coal-fired Thermal Power Plant (700 MW)

**Location:** Pagbilao, Quezon

**Status:** Operational

**Owner:** Pagbilao Energy Corp., a 50-50 joint venture between Team Energy Philippines and Aboitiz Power Corp, through wholly-owned subsidiary Therma Power, Inc.<sup>74</sup>

### Financial links to RCBC:

- In July 2015, RCBC was a participating underwriter for \$525 million in bond issues for Aboitiz Equity Ventures Inc., the majority owner (76.88%) of Aboitiz Power Corp.<sup>75</sup>

<sup>72</sup> <http://infopub.sgx.com/FileOpen/SMC%20Global%20Power%20Holdings%20Consolidated%20AFS%20December%20312015.ashx?App=Announcement&FileID=399667>

<sup>73</sup> Thomson One Database

<sup>74</sup> <http://aboitizpower.com/wp-content/uploads/AP-SEC-Form-17A-Annual-Report-PSE-Full-Report.pdf>

<sup>75</sup> [Prospectus](#)

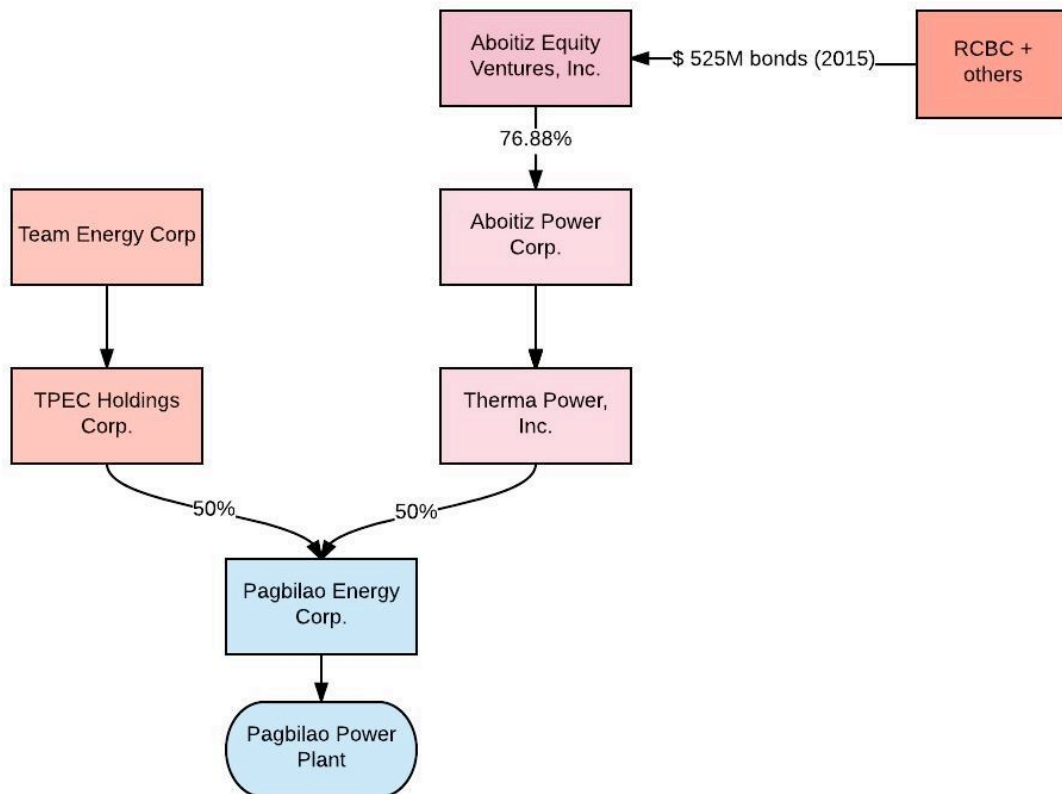

## 12. Atimonan One Energy (AOE) Power Plant (1,200 MW)

**Location:** Atimonan, Quezon

**Status:** Proposed

**Owner:** Meralco Powergen, a wholly-owned subsidiary of Manila Electric. Atimonan One Energy, Inc. (A1E) is the project operator.<sup>76</sup>

### **Financial links to RCBC:**

- In December 2013, RCBC was a participating underwriter of two issues of Manila Electric bonds worth \$419 million.<sup>77</sup>

<sup>76</sup> [http://www.meralcopowergen.com.ph/our\\_business/view/5](http://www.meralcopowergen.com.ph/our_business/view/5)

<sup>77</sup> [Prospectus](#)

- In February 2014, RCBC was co-lead underwriter for three issues of JG Summit Holdings bonds worth \$672 million.<sup>78</sup> Net proceeds from the bonds were intended to partially finance JG Summit's acquisition of Manila Electric Company and partially for general corporate purposes.<sup>79</sup> JG Summit Holdings acquired a 29% stake in Manila Electric Company in December 2013.<sup>80</sup>

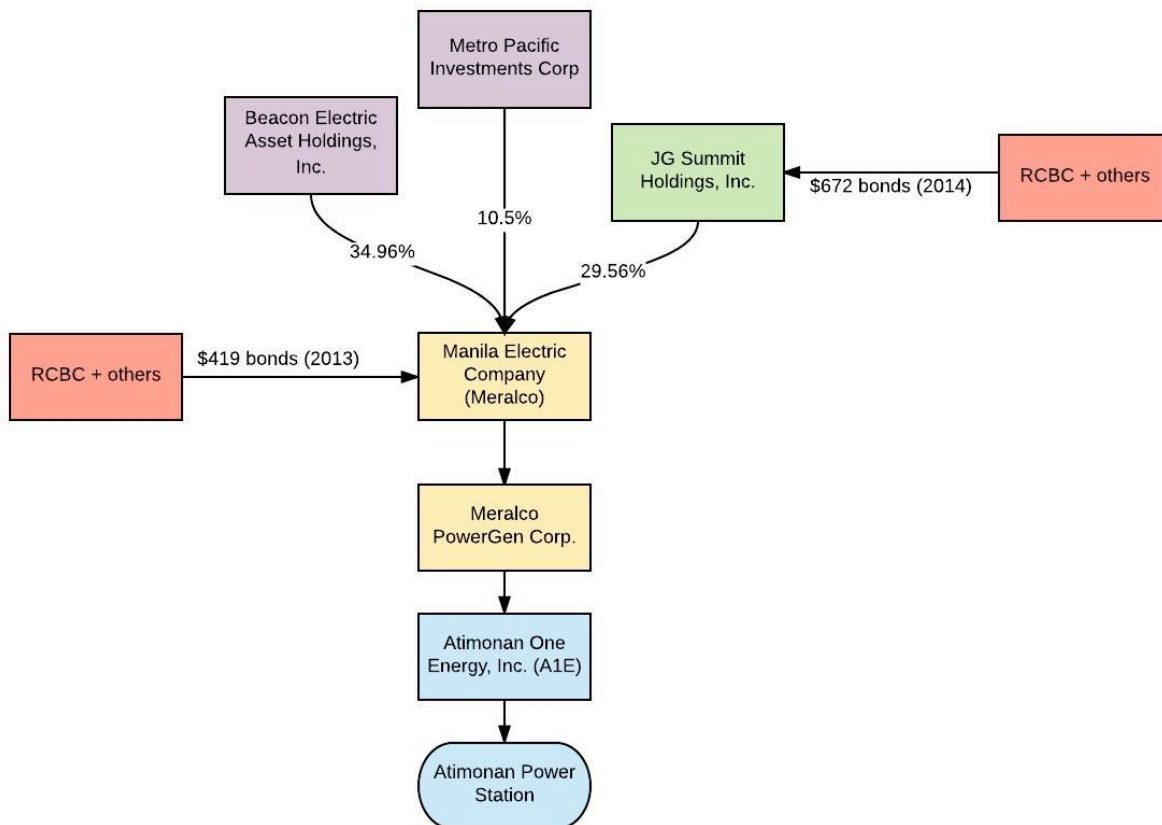

### 13. Toledo Power Corp. (TPC) Plant (63 MW)

**Location:** Toledo, Cebu, Central Visayas

**Status:** Operational

**Owner:** Toledo Power Co. (TPC), subsidiary of Global Business Power.<sup>81</sup>

#### Financial links to RCBC:

- In March 2013, RCBC was co-arranger of a \$139 million loan to be used for the construction of Toledo power plant.<sup>82</sup>
- RCBC has provided financial support to Manila Electric and JG Summit Holdings, which hold large stakes in Global Business Power Corp, at 14% and 30%, respectively.<sup>83</sup>

<sup>78</sup> [Prospectus](#)

<sup>79</sup> <http://business.inquirer.net/165085/jg-summit-raises-p30b-from-retail-bond-offer>

<sup>80</sup> <http://www.jgsummit.com.ph/meralco>

<sup>81</sup> <http://www.gbpc.com.ph/our-power-plants/>

<sup>82</sup> Thomson One Database

<sup>83</sup> <http://www.gbpc.com.ph/the-company/>



- In December 2013, RCBC was a participating underwriter of two issues of Manila Electric Company bonds worth a total of \$419 million.<sup>84</sup>
- In February 2014, RCBC was co-lead underwriter for three issues of JG Summit Holdings bonds worth \$672 million.<sup>85</sup> Net proceeds from the bonds were intended to partially finance JG Summit's acquisition of Manila Electric Company and partially for general corporate purposes.<sup>86</sup> JG Summit Holdings acquired a 29% stake in Manila Electric Company in December 2013.<sup>87</sup>

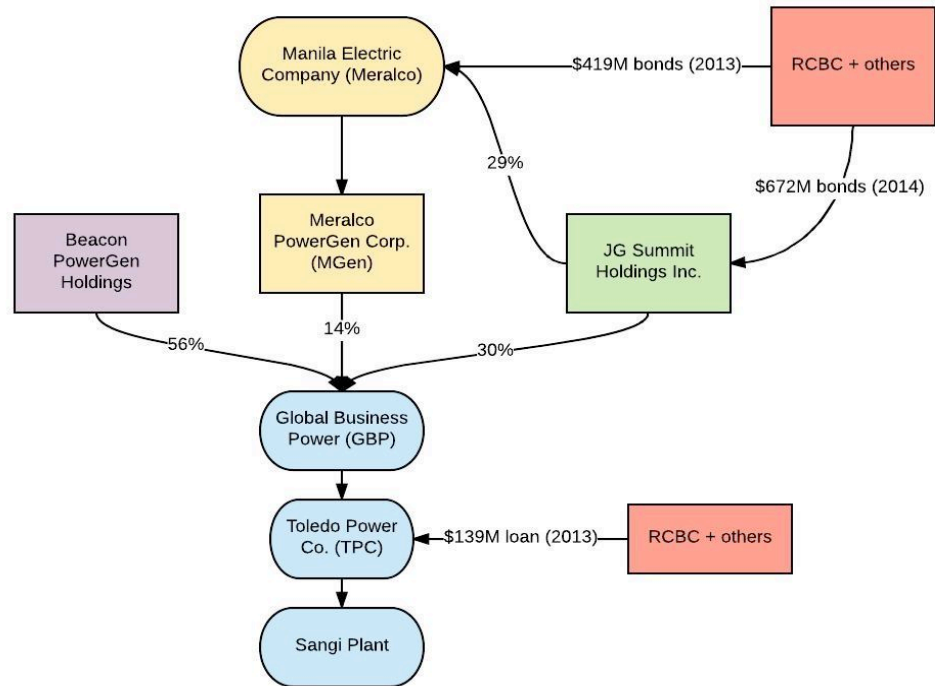

#### 14. Panay Power Station Expansion Project (164 MW + 150 MW expansion)

**Location:** La Paz, Iloilo City, Iloilo

**Status:** Operational

**Owner:** Panay Energy Development Corp. (PEDC), a wholly-owned subsidiary of Global Business Power.<sup>88</sup>

##### Financial links to RCBC:

- In 2010 (pre-dating IFC's exposure), RCBC was part of a consortium that provided a \$303 million loan to PEDC for construction of the original 164MW Panay Power Station.<sup>89</sup>
- In April 2015, RCBC was part of a consortium that provided a \$245 million loan to PEDC for a 150MW expansion of the station.<sup>90</sup>

<sup>84</sup> [Prospectus](#)

<sup>85</sup> [Prospectus](#)

<sup>86</sup> <http://business.inquirer.net/165085/jg-summit-raises-p30b-from-retail-bond-offer>

<sup>87</sup> <http://www.jgsummit.com.ph/meralco>

<sup>88</sup> <http://www.gbpc.com.ph/our-power-plants/>

<sup>89</sup> Thomson One Database

- RCBC has provided financial support to Manila Electric and JG Summit Holdings, which hold large stakes in Global Business Power Corp, at 14% and 30%, respectively.<sup>91</sup>
  - In December 2013, RCBC was a participating underwriter of two issues of Manila Electric Company bonds worth a total of \$419 million.<sup>92</sup>
  - In February 2014, RCBC was co-lead underwriter for three issues of JG Summit Holdings bonds worth \$672 million.<sup>93</sup> Net proceeds from the bonds were intended to partially finance JG Summit's acquisition of Manila Electric Company and partially for general corporate purposes.<sup>94</sup> JG Summit Holdings acquired a 29% stake in Manila Electric Company in December 2013.<sup>95</sup>

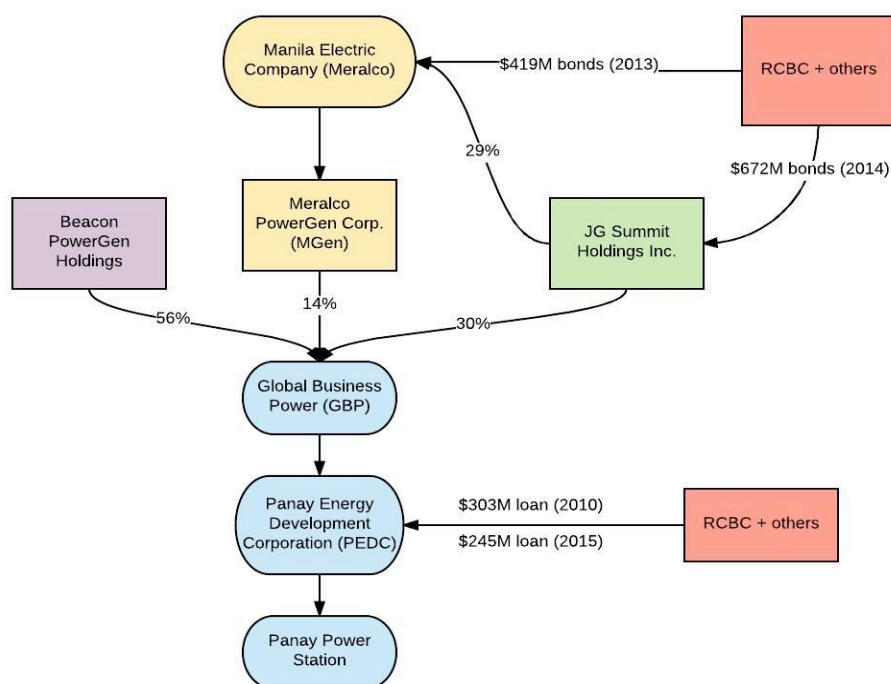

## 15. Therma Visayas Energy Project (300 MW)

**Location:** Toledo City, Cebu

**Status:** Construction underway

**Owner:** Therma Visayas, Inc., majority-owned (80%) by Aboitiz Equity Ventures, Inc. through subsidiary Aboitiz Power Corp.<sup>96</sup>

### Financial links to RCBC:

- In July 2015, RCBC was a participating underwriter for \$525 million in bond issues for Aboitiz Equity Ventures Inc.<sup>97</sup>

<sup>90</sup> Thomson One Database; and <http://www.gbpc.com.ph/2015/04/panay-energy-secures-php11b-loan-facility-for-expansion-project/>

<sup>91</sup> <http://www.gbpc.com.ph/the-company/>

<sup>92</sup> [Prospectus](#)

<sup>93</sup> [Prospectus](#)

<sup>94</sup> <http://business.inquirer.net/165085/jg-summit-raises-p30b-from-retail-bond-offer>

<sup>95</sup> <http://www.jgsummit.com.ph/meralco>

<sup>96</sup> <http://aboitizpower.com/generation/coal/>

## 16. Southern Mindanao Coal Fired Power Plant (150 MW +105 MW expansion)

**Location:** Maasim, Sarangani

**Status:** Expansion

**Owner:** Sarangani Energy Corp

**Financial links to RCBC:**

- In December 2013, RCBC was joint lead arranger of a \$227 million loan to Sarangani Energy Corp for the construction of a 150MW coal plant project.<sup>98 99</sup>
- In May 2017, the same consortium provided an additional \$206 million loan for the expansion of the plant.<sup>100</sup>

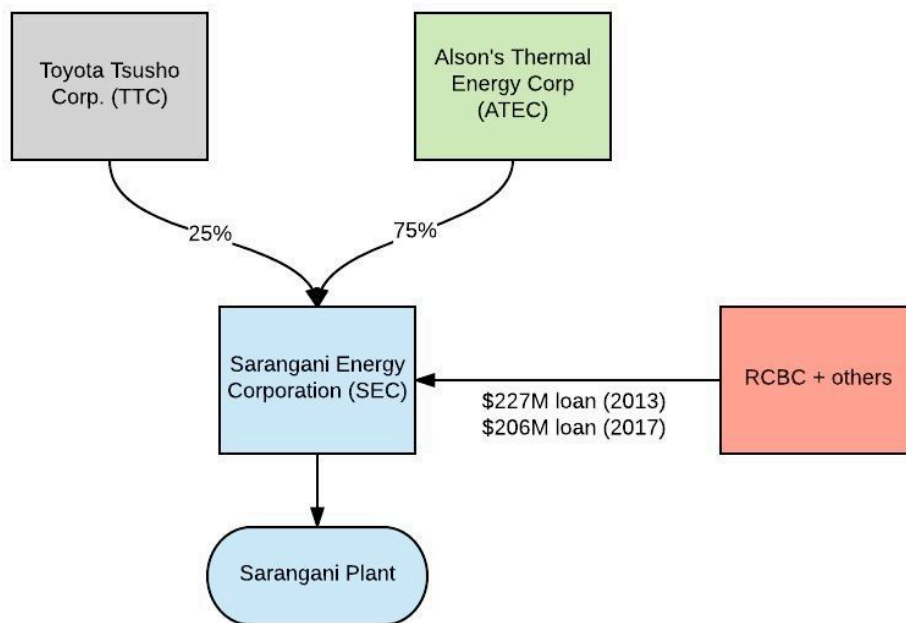

## 17. Lanao Kauswagan Power Plant (540 MW)

**Location:** Kauswagan, Lanao del Norte

**Status:** Construction Underway

**Owner:** GNPowder Kauswagan Ltd., a joint venture between AC Energy (a wholly-owned subsidiary of Ayala Corp) in partnership with the Philippine Investment Alliance for Infrastructure Fund (PINAI) and Power Partners Ltd Co. AC Energy has an 85% stake in the project.<sup>101</sup>

**Financial links to RCBC:**

---

<sup>97</sup> [Prospectus](#)

<sup>98</sup> [http://www.alsonspower.com/news.php?news\\_id=11&start=5&category\\_id=0&parent\\_id=0&areyear=&aremonth=](http://www.alsonspower.com/news.php?news_id=11&start=5&category_id=0&parent_id=0&areyear=&aremonth=)

<sup>99</sup> Bloomberg Database

<sup>100</sup> Bloomberg Database

<sup>101</sup> <http://www.ayala-energyinfra.com/ac-energy/conventional-energy/gnpowderkauswagan/>

- In June 2015, RCBC was co-arranger of three loan tranches amounting to \$390 million for the construction of the Lanao Kauswagan project.<sup>102</sup>
- In 2016, RCBC contributed \$85 million to a \$765 million loan for plant expansion.<sup>103</sup>
- In May 2011, RCBC was joint bookrunner for \$232 million in Ayala Corp. bonds for working capital.
- In May and November 2012, RCBC was joint bookrunner for an Ayala Corp bonds issue worth \$235 million and \$244 million, respectively.<sup>104</sup>

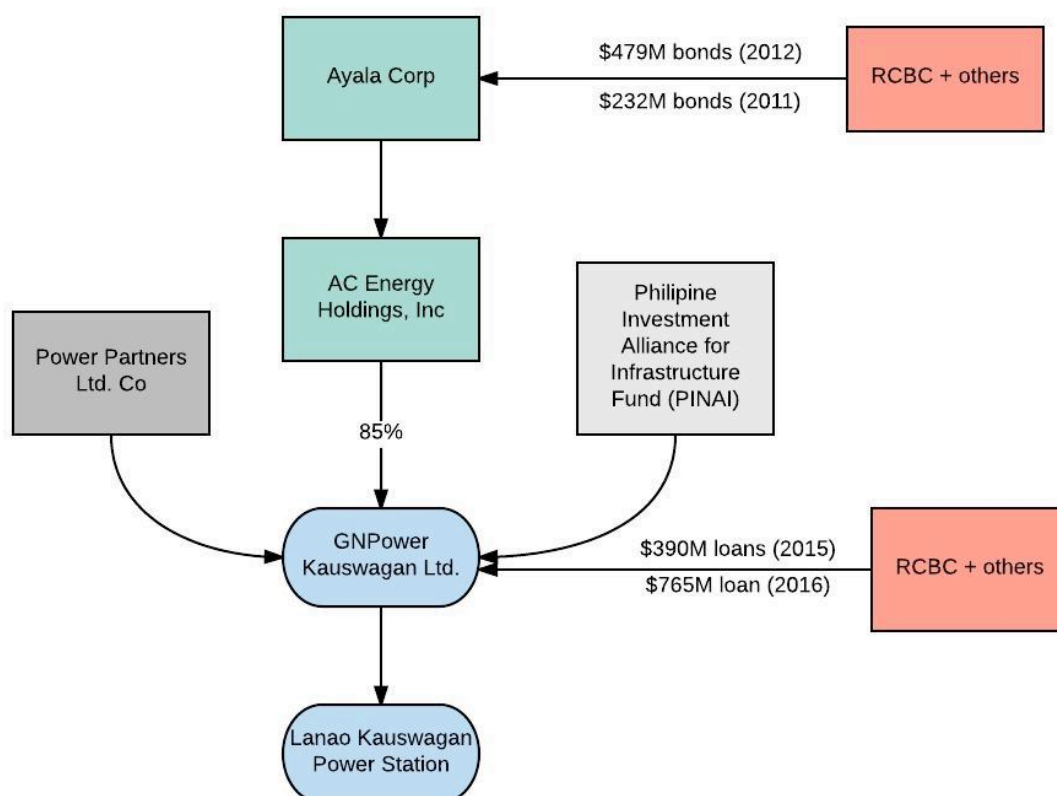

## 18. Davao Therma South Power Station I (300 MW)

**Location:** Davao City, Davao del Sur

**Status:** Operational

**Owner:** Therma South Inc., a wholly-owned subsidiary of Aboitiz Power Corp.<sup>105</sup>

### Financial links to RCBC:

- In July 2015, RCBC was a participating underwriter for \$525 million in bond issues for Aboitiz Equity Ventures Inc., majority owner (76.88%) of Aboitiz Power Corp.<sup>106</sup>

<sup>102</sup> Bloomberg Database

<sup>103</sup> <https://ppi.worldbank.org/snapshots/project/Kauswagan-Coal-Fired-Power-Plant-Expansion-8731>

<sup>104</sup> Thomson One Database

<sup>105</sup> <https://abotizpower.com/wp-content/uploads/AP-SEC-Form-17A-Annual-Report-PSE-Full-Report.pdf>

<sup>106</sup> [Prospectus](#)

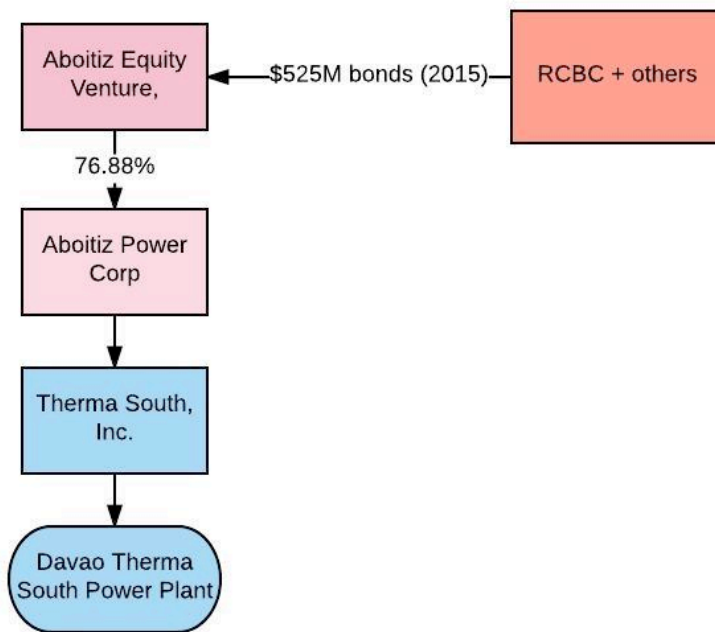

### 19. SMC Global Power Coal Plant (300 MW)

**Location:** Malita, Davao Occidental

**Status:** Operational

**Owner:** SMC Global Power Holdings Corp., a wholly-owned subsidiary of San Miguel Corp. San Miguel Consolidated Power Corp. (SMCPC) is the project operator. .<sup>107</sup>

**Financial links to RCBC:**

- In March and April 2017, RCBC was joint bookrunner for San Miguel Corp. bonds issues at \$397 million and \$200 million, respectively.
- In July 2016, RCBC was joint bookrunner for three San Miguel Corp Global Power Holdings bond issues worth \$316 million.<sup>108</sup>

<sup>107</sup> [http://www.smcglobalpower.com.ph/File\\_list/PDF/Other/Amended\\_SMC\\_Global\\_Annual\\_Report\\_2016\\_\(17-A\).pdf](http://www.smcglobalpower.com.ph/File_list/PDF/Other/Amended_SMC_Global_Annual_Report_2016_(17-A).pdf)

<sup>108</sup> Thomson One Database

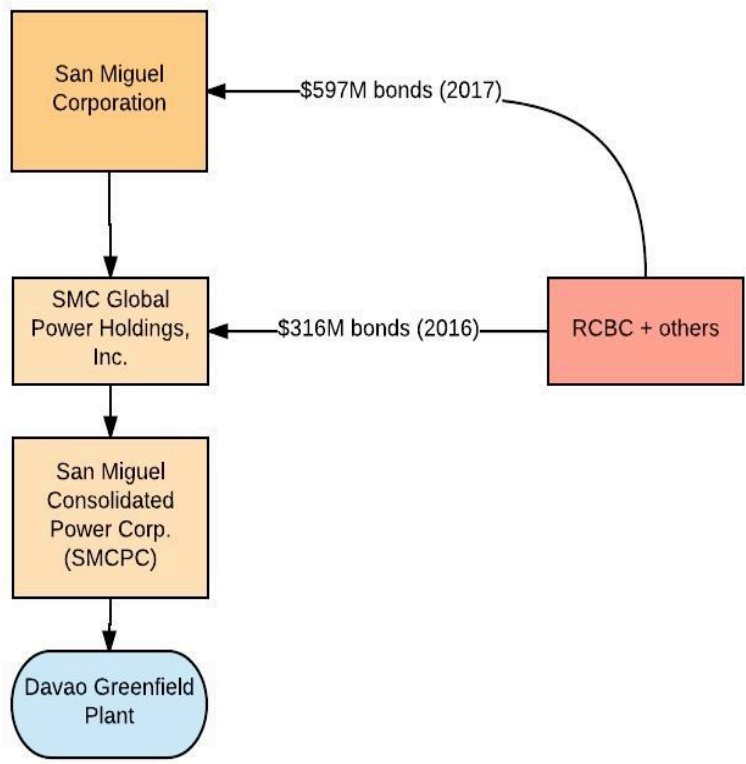

## Annex 2: Table of Harms

Project/location	Status	Harms and anticipated harms *Non-exhaustive description of harms. **Further detail on some harms available on request.
1. Global Luzon Power Plant, La Union, Luzon	Proposed	Local communities have not been properly informed or meaningfully consulted, and fear negative impacts as experienced by other communities living near operational plants.
2. Masinloc Power Plant Expansion Project, Masinloc, Zambales, Luzon	Expansion	The plant has affected fisheries. There is less catch for fisherfolk, who now must go farther out to sea to fish, which has increased their expenses. Their daily income is now not enough to sustain their families. There has also been destruction of seaweed, also a livelihood resource. Seaweed farmers have had to leave the area in order to earn a living elsewhere. There have also been impacts on crops and fruit trees.
3. Redondo Peninsula Energy Subic Power Plant, Subic, Zambales, Luzon	Construction underway	Local communities have not been properly informed or meaningfully consulted and fear negative impacts as experienced by other communities living near operational plants.
4. GNPower Mariveles Power Plant and Dinginin Power Station Expansion, Mariveles, Bataan	Expansion	<p>Local communities have not been properly informed or meaningfully consulted and some groups have been excluded altogether.</p> <p>The operating plant has emitted a foul odor. There has been a lot of respiratory disease in the community since the coal plant began operation. There have also been skin irritations. Some domesticated animals have died, believed to have been caused by the plant.</p> <p>Fisherfolk are no longer allowed to fish in the area, despite this being the main source of livelihood. Fences were built to protect the vicinity of the coal plant and block fishers' access. When fisherfolk try to get close to the area, private guards fire warning shots. In addition, fishing areas have been gradually affected as waters are contaminated.</p> <p>Local residents have been evicted with minimal compensation (according to one resident, ranging from 50 to 100 pesos).</p> <p>Part of the land that was fenced off belonged to an indigenous community.</p> <p><b>(Annex 2-A)</b></p>
5. Limay Power Plant, Limay, Bataan	Phase 1 Operational Phase 2 Construction underway	<p>Local communities have not been properly informed or meaningfully consulted. Only some people were invited to a public scoping. A public hearing was only conducted after the plant was already constructed <b>(Annex 2-B)</b>.</p> <p>The company broke its promise to some residents to provide job opportunities (importing workers from Manila instead).</p> <p>Fly ash from the plant scatters all over the communities – no prevention measures are in place. Fly ash has caused severe skin and lung disease. The company denied this, saying skin rashes were caused by dogs and refuses to remedy harms. <b>(Annex 2-C)</b></p> <p>Plants, crops, and rivers have been polluted by continuous scattering of fly ash. Fruit bearing trees are not as productive as before the coal plant was built.</p> <p>Residents have been evicted. Some were relocated, but to areas without livelihood opportunities. Some received</p>

		30,000 to 60,000 pesos and had to promise not to return to Limay.
<b>6. Mariveles Power Generation Corp. Power Plant, Mariveles, Bataan</b>	Construction underway	The residents of Mariveles Bataan have already suffered harmful impacts from the operating GNPowder Mariveles Coal Plant in the area (see project 4 above). The operation of the previous plant has caused many residents to suffer health impacts and there has been serious damage to the environment. Trees were cut during plant construction, and many plants died when it started operation. This has a serious affect on families' livelihoods, because their livestock (goats and cows) depended on the forest. Residents are concerned about facing similar and cumulative harmful impacts from the new plant.
<b>7. South Luzon Thermal Energy Corp. Puting Bato Power Plant, Puting Bato, Calaca, Batangas</b>	Operational	Farmers are complaining about dying crops and plants surrounding the facility because of coal ash. Water sources are have been impacted, with artesian pump wells in the community drying up. The construction of the coal plant eroded the shoreline, which has affected livelihoods, as in the case of a resident's rest house business <b>(Annex 2-D)</b>
<b>8. Merbau Coal-fired Thermal Plant, Batangas City, Batangas</b>	Proposed	<p>The community of Brgy. Pinamucan Ibaba is already suffering from the harmful effects of the naphtha cracker plant in the area, which is also owned by JGSummit. They have long been complaining about its health impacts, but they have received no compensation or assistance. They are very concerned that these effects will be aggravated when the proposed JS Summit coal project becomes operational. There was a public hearing about the proposed coal plant in 2015, but the risks and impacts were not explained properly and community questions were not satisfactorily answered. <b>(Annex 2-E)</b></p> <p>Community opposition to the project was expressed through several letters, including one to the Mayor of Batangas from Archbishop Ramon Aruelles of the Archdiocese of Lipa, Batangas. <b>(Annex 2-F)</b>. Despite this and other measures opposing the project, the city council granted the zoning clearance to allow construction of the coal plant.</p> <p>The company conducted an EIA discussing use of circulating fluidized bed (CFB) technology, which it claimed to be clean and less harmful, but the experience of communities affected by another CFB coal plant in Naga Cebu, suggests this is incorrect and that local communities face serious harms.</p> <p>There have been impacts on livelihoods, including crab collection, because the company has blocked access to the shore. See case of a resident who used to collect small crabs <b>(Annex 2-F)</b>.</p> <p>Approx. 20 houses have already been demolished in preparation of the construction of the coal plant. Affected residents were offered some compensation, but there was no definite resettlement plan. No resettlement area was offered, and the residents had to find their own alternative housing.</p> <p>Residents used to enjoy swimming and fishing in Wawa Beach, which was located in front of the proposed project. Now the beach has been wiped out in preparation of the project's construction <b>(Annex 2-F)</b>.</p>
<b>9. San Buenaventura</b>	Expansion	A study by the Health Care Ministry in Quezon has shown



<p><b>Power Ltd. Co. Project,</b> Mauban, Quezon</p>		<p>that the incidence of tuberculosis has increased since the operation of the existing 511MW Quezon Power Plant in Mauban, Quezon. According to <a href="#">a study by Greenpeace</a>, the operational coal plant in Mauban, Quezon revealed “insidious presence of heavy metals: mercury, arsenic, carcinogen, as well as the hazardous substances lead and chromium.” Heavy metals are proven to have serious impacts on water biodiversity, which is one of the main sources of livelihood of residents in Mauban.</p> <p>The community fears further incidences of respiratory disease and other negative impacts to their health and the environment due to the expansion.</p>
<p><b>10. Central Luzon Premiere Power Corporation Plant Project,</b> Pagbilao, Quezon</p>	Proposed	<p>Public consultations were held in July 2016 and February 2017, but there was little information with no clarity about what the consultation was actually for. Residents were not sure whether it meant they were registering their approval even though they are opposed to coal plants. They were given an opportunity to register their opinions, but there is no indication that their opinions were taken into account. They requested a copy of the minutes of the public scoping, but were not given it.</p> <p>Complainants fear negative impacts as experienced by other communities living near operational plants.</p>
<p><b>11. Pagbilao Coal-fired Thermal Power Plant,</b> Pagbilao, Quezon</p>	Operational	<p>The flow of water in the river was affected because of the blasting of mountains in preparation for the construction of the now operational coal plant. A 10-hectare area in the sea was covered with land, affecting fisheries.</p> <p>Fishermen face threats whenever they come near the area to fish.</p> <p>People who were displaced were provided with a resettlement area but without water supply. The residents are still forced to buy water from other sources. No livelihood support or opportunities were provided.</p>
<p><b>12. Atimonan One Energy (AOE) Power Plant,</b> Atimonan, Quezon</p>	Proposed	<p>A public consultation was held in May 2015. Attendees observed that it was “overly biased in favor of the proponent” and “lacked important details that would explain its calculated impacts.” (<b>Annex 2-G</b>).</p> <p>According to some community members, they were not aware of the change from Liquefied Natural Gas (LNG), as initially proposed by AOE, to coal.</p> <p>The community is concerned that they will be economically displaced and not provided with any job opportunities by the company.</p> <p>They are also concerned of negative health impacts.</p> <p>The proposed plant is located in the periphery of Lamong Bay causing a direct threat to the bay.</p>
<p><b>13. Toledo Power Corp. (TPC) Plant,</b> Toledo, Cebu, Central Visayas</p>	Operational	<p>All the coal ash generated is being dumped indiscriminately around the open spaces in Toledo City and its immediate environs. This has caused serious harms, including pollution of seawaters surrounding the plant.</p> <p>The company has not put any prevention and mitigation measures in place.</p>
<p><b>14. Panay Power Station Expansion Project,</b> La Paz, Iloilo City, Iloilo</p>	Expansion	<p>Residents from Brgy. Nipa, Concepcion, Iloilo complained of lung problems and skin diseases.</p>
<p><b>15. Therma Visayas</b></p>	Construction	<p>Local communities have not been properly informed or</p>

<b>Energy Project,</b> Toledo City, Cebu	underway	meaningfully consulted and fear negative impacts as experienced by other communities living near operational plants, especially nearby TPC plant (project 13).
<b>16. Southern Mindanao Coal Fired Power Plant,</b> Maasim, Saranggani	Expansion	Some members of the B'laan tribe have been displaced from their ancestral lands, without any process of FPIC. Residents have been experiencing severe stomach aches, which according to the municipal health office, are caused by water contamination ( <b>Annex 2-H</b> ). The coal plant threatens the Tino-Tampuan coral reef, a protected area.
<b>17. Lanao Kauswagan Power Plant,</b> Kauswagan, Lanao del Norte	Construction underway	In August 2016, 321 families were evicted and resettled to an unfinished site, with no security of tenure. Residents were asked to relocate to unfinished housing units with unsafe electrical wiring and poor construction, muddy roads, and no water for the housing units.
<b>18. Davao Therma South Power Station I,</b> Davao City, Davao del Sur	Expansion	The proposed construction of a protection dike did not occur, resulting in flooding incidences, which affected 300 households. It also made the barangay roads impassable. The company also failed in its promise to plant trees in a buffer zone. Water supply was also affected ( <b>Annex 2-I</b> ). There is a significant decrease in volume of fish as a result of mangrove destruction brought about by the plant's operation, affecting livelihoods. Ash dusts also resulted in foul odors, affecting the health of villagers. There were also cases of harassment by the facility's security guard. ( <b>Annex 2-J</b> )
<b>19. SMC Global Power Coal Plant</b> Malita, Davao Occidental	Proposed	Local communities have not been properly informed or meaningfully consulted and fear negative impacts as experienced by other communities living near operational plants.

#### LIST OF ANNEXES:

- Annex 2-A – Outcome of Community Dialogue in Mariveles, Bataan
- Annex 2-B – Outcome of Community Dialogue in Limay, Bataan
- Annex 2-C – News Report on SMC Limay Coal Plant Fly Ash
- Annex 2-D – Testimony of Batangas Resident
- Annex 2-E – Testimony of Batangas Resident
- Annex 2-F – Demand Letter to Mayor of Batangas
- Annex 2-G – Demand Letter from Quezon Community
- Annex 2-H – Testimony of Saranggani Resident
- Annex 2-I – Affidavit of a Davao Resident
- Annex 2-J – Joint Affidavit of Davao Residents